



MIDGET

Driver's Handbook



A B.M.C. PUBLICATION

To get the best out of
your M.G. Midget...

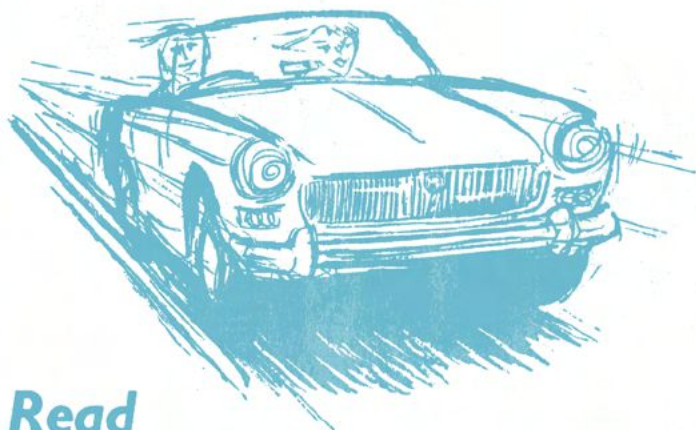

Read
Safety Fast

*the magazine for those
who practise driving as an art*

Published by the makers of your car and packed with features on

- DRIVING TECHNIQUE
- TUNING FOR PERFORMANCE
- SPORTS CAR HISTORY
- CLUB NEWS

Official Organ of the M.G. Car Club

40 Pages * 1s. 6d. Monthly

*Subscription rates: U.K., £1; U.S.A. and Canada, \$3;
elsewhere, £1 5s. or equivalent*

*Order your copy now, posted direct to you, from
'Safety Fast', British Motor Corporation Ltd.,
Abingdon-on-Thames, England*



MIDGET

Mark II

(Including Supplement for Mark I)

DRIVER'S HANDBOOK

Published by
THE M.G. CAR COMPANY LIMITED

Proprietors: Morris Motors Limited
ABINGDON-ON-THAMES

Phone: Abingdon 251-2-3-4

Grams: Emgee, Abingdon

Sole Exporters
NUFFIELD EXPORTS LIMITED

Proprietors: Morris Motors Limited
COWLEY - OXFORD - ENGLAND

Phone: Oxford, England, 77733

Telex: 83133 Morex, Oxford, England

Cables: Morex, Oxford, England

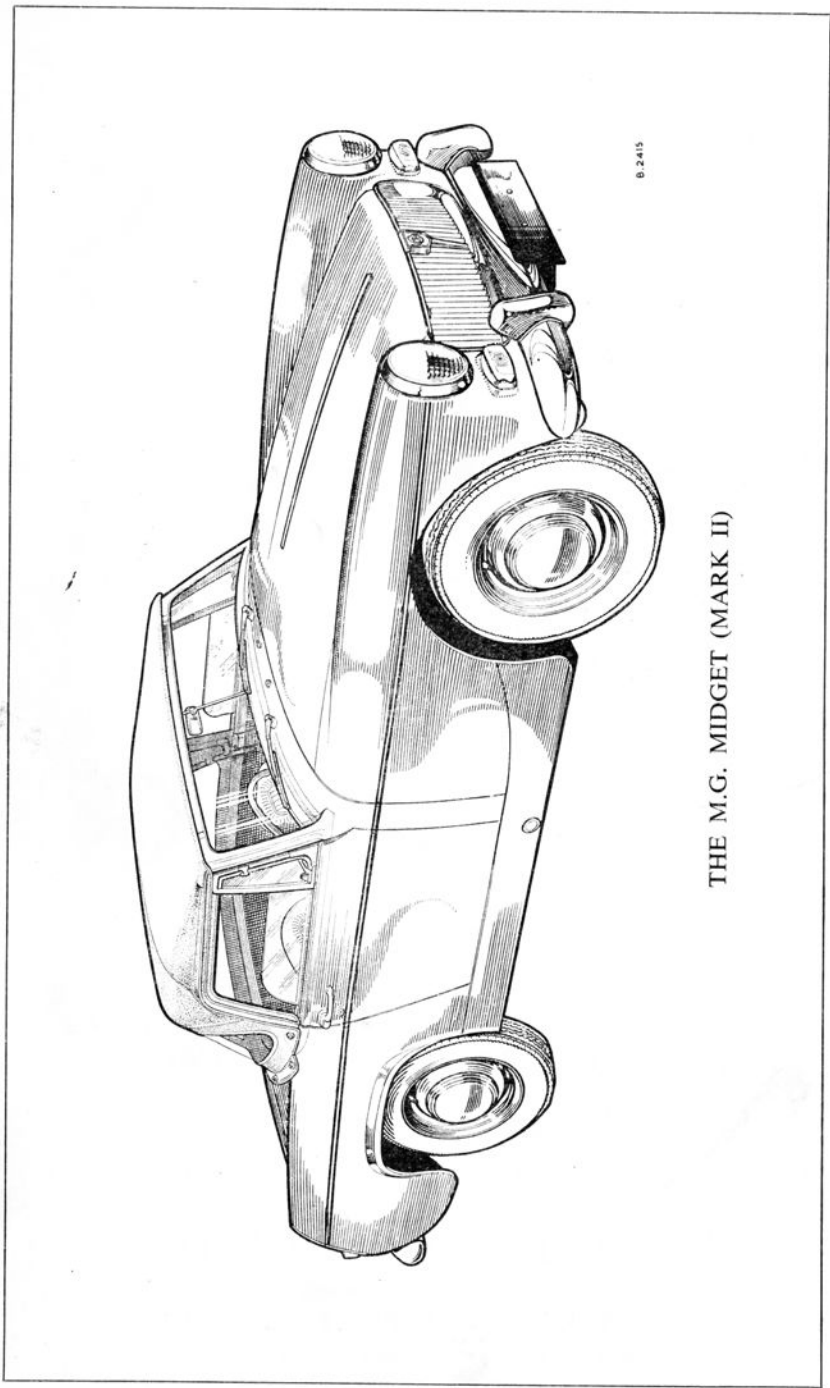

8.2415

THE M.G. MIDGET (MARK II)

FOREWORD

IN producing this book the object has been to confine the contents to information essential to the proper running and operation of the vehicle. Nevertheless, the operator will find all the guidance necessary to maintain the vehicle in first-class condition and to ensure trouble-free service. Every vehicle leaving the Factory is capable of giving absolute satisfaction if the maintenance instructions detailed in the following pages are carefully carried out. Remember that an authorized Distributor/Dealer is better equipped to provide routine and repair service than any other operator; he is at your service and should be consulted if you encounter trouble. When emergency work has been undertaken by other than a franchise holder the vehicle should be submitted to an authorized Distributor/Dealer for checking.

All Warranty work must be carried out by an authorized Distributor/Dealer.

When communicating with your Distributor/Dealer always quote the car and engine numbers; the registration number is of no use and is not required.

For those wanting information of a more detailed and technical nature than is contained in this Handbook a Workshop Manual is available at a reasonable price from your Distributor/Dealer.

IDENTIFICATION

Car number. Stamped on a plate secured to the left-hand inner wheel arch, under the bonnet.

Engine number. Stamped on a plate secured to the right-hand side of the cylinder block.

Gearbox number. Stamped on the top of the gearbox casing.

Rear axle number. Stamped on the front of the left-hand rear axle tube near the spring seating.

Ignition key number. To reduce the possibility of theft ignition switches on later cars are **not** marked with a number. Owners are advised to make a note of the number stamped on their ignition key in case of future loss.

NOTE.—References to right or left hand in this Handbook are made when viewing the car from the rear.

GENERAL DATA

Engine

Engine type	10CG (4-cylinder overhead-valve)
Bore	2.543 in. (64.58 mm.)
Stroke	3.296 in. (83.72 mm.)
Cubic capacity	67 cu. in. (1098 c.c.)
Compression ratio	8.9 : 1 or 8.1 : 1
Firing order	1, 3, 4, 2
Valve rocker clearance (cold)012 in. (.305 mm.)
Idling setting	1,000 r.p.m. (hot)
Oil pressure:		
Normal (approx.)	30 to 60 lb./sq. in. (2.1 to 4.2 kg./cm. ²)
Idling (approx.)	10 to 25 lb./sq. in. (.7 to 1.7 kg./cm. ²)

Ignition

Sparking plugs	Champion N5 (14 mm.)
Sparking plug gap024 to .026 in. (.625 to .660 mm.)
Static ignition timing	(H.C.) 5° B.T.D.C. (L.C.) 3° to 5° B.T.D.C.
Contact breaker gap014 to .016 in. (.35 to .40 mm.)

Fuel System

Carburettors	HS2
Carburettor needles	Standard AN, Weak GG, Rich H6
Spring	Blue
Pump	S.U. (Electric)

Wheels and Tyres

Wheel size	3.5D × 13
Tyre size	5.20—13
Tyre pressures:		
All conditions:		
Front	18 lb./sq. in. (1.27 kg./cm. ²)
Rear	20 lb./sq. in. (1.41 kg./cm. ²)
For sustained speeds in excess of 80–85 m.p.h. (129–137 km.p.h.):		
Front	22 lb./sq. in. (1.55 kg./cm. ²)
Rear	24 lb./sq. in. (1.69 kg./cm. ²)

Transmission

Rear axle ratio	4.22 : 1
Overall gear ratios:		
First	13.504 : 1
With synchromesh	{	
Second	8.085 : 1
Third	5.726 : 1
Fourth	4.22 : 1
Reverse	17.395 : 1

Dimensions

		<i>Wire wheels</i>	<i>Disc wheels</i>
Track: Front	3 ft. 10 ¹¹ / ₁₆ in. (1.17 m.)	3 ft. 10 ¹¹ / ₁₆ in. (1.17 m.)
Rear	3 ft. 9 ¹ / ₄ in. (1.15 m.)	3 ft. 8 ³ / ₄ in. (1.14 m.)

GENERAL DATA

Turning circle: Left lock	32 ft. 1 ¹ / ₂ in. (9.79 m.)
Right lock	31 ft. 2 ¹ / ₂ in. (9.51 m.)
Front wheel alignment	Parallel to ¹ / ₈ in. toe-in (0 to 3.2 mm.)
Wheelbase	6 ft. 8 in. (2.03 m.)
Overall length	11 ft. 5 ¹ / ₄ in. (3.45 m.)
Overall width	4 ft. 5 in. (1.35 m.)
Overall height	4 ft. 1 ³ / ₄ in. (1.25 m.)
Ground clearance	5 in. (12.7 cm.)

Weight

Dry weight	1,490 lb. (66 kg.)
------------	---------	--------------------

Capacities

Fuel tank	6 gallons (7.2 U.S. gallons, 27.3 litres)
Engine sump (including filter)	6 ¹ / ₂ pints (7.8 U.S. pints, 3.7 litres)
Gearbox	2 ¹ / ₄ pints (2.7 U.S. pints, 1.3 litres)
Rear axle	1 ¹ / ₂ pints (1.8 U.S. pints, .85 litre)
Cooling system (without heater)	10 pints (12 U.S. pints, 5.68 litres)
Heater	¹ / ₂ pint (.6 U.S. pint, .253 litre)

28

CONTROLS AND INSTRUMENTS

Hand brake

The hand brake is of the pull-up lever type, operating mechanically on the rear wheels only. To release the hand brake, pull it upwards to take the load, press the ratchet release button located in the end of the lever with the thumb and push the lever down into the off position. The hand brake is automatically adjusted at the same time as the foot brake and requires no separate adjustment.

Pedals

The left-hand pedal operates the clutch, the centre pedal the brakes, and the right-hand pedal the accelerator. Keep the foot clear of the clutch pedal except when engagement or disengagement of any gear is intended, or when in heavy traffic. Driving with the foot resting on the pedal will lead to rapid clutch wear.

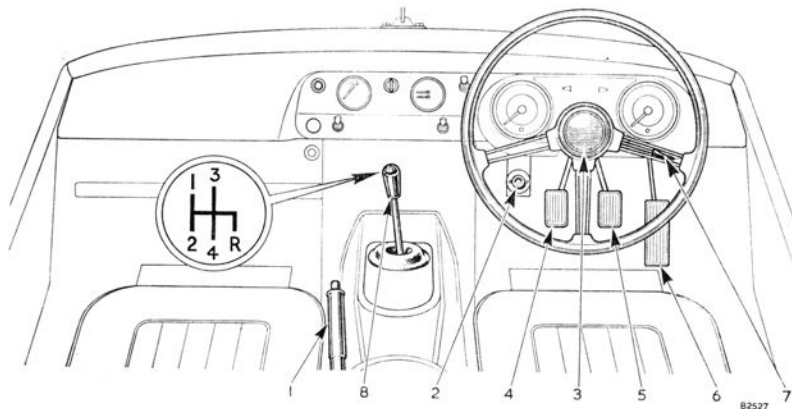

Driving controls—right-hand drive

- | | |
|--------------------------|-------------------------|
| 1. Hand brake. | 5. Brake pedal. |
| 2. Headlight dip switch. | 6. Accelerator pedal. |
| 3. Horn switch. | 7. Direction indicator. |
| 4. Clutch pedal. | 8. Gear lever. |

Gear lever

The gear positions are indicated on the lever knob; make certain that the lever is in the neutral position before starting the engine. First and second gears are selected by moving the lever to the left, and engaged by moving it forward into first gear and backwards into second gear. Third and fourth gears are selected by moving the lever to the right through the neutral position until resistance is felt, then forward into third gear and backwards into fourth gear.

To engage reverse gear move the lever to the right in the neutral position until resistance is felt, apply further side pressure to overcome the resistance and then move it backwards to engage the gear. Synchromesh is provided on second, third, and fourth gears.

Horn switch

The horn is sounded by pressing the centre disc of the steering-wheel.

CONTROLS AND INSTRUMENTS

Ignition and starter switch

The ignition and starter are both controlled by a single switch operated by a removable key. To switch on the ignition insert the key and turn it in a clockwise direction until a slight resistance is felt. Further movement in the same direction will operate the starter motor. Release the key immediately the engine starts. If the engine fails to start first time wait until it has come to rest before using the starter again.

Headlight beam dipping switch

The headlight main-beam dipping switch is located on the toeboard to the left of the clutch pedal. It is of the single-acting repeating type, lowering the beams on one application and raising them on the next. A warning light on the face of the speedometer will glow when the beams are in the raised position.

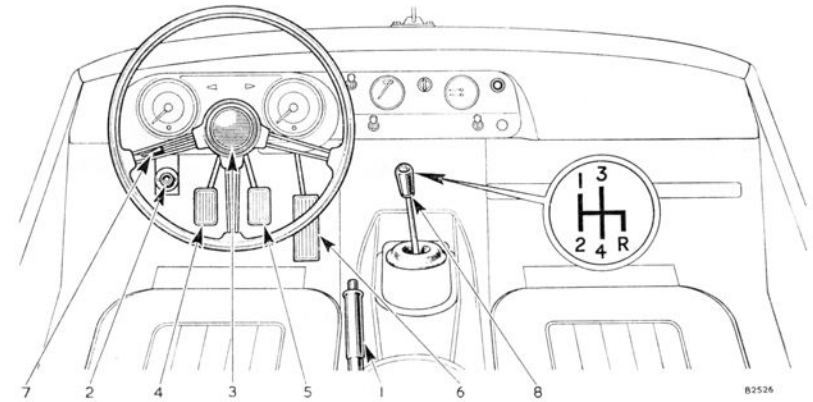

Driving controls—left-hand drive

- | | |
|--------------------------|-------------------------|
| 1. Hand brake. | 5. Brake pedal. |
| 2. Headlight dip switch. | 6. Accelerator pedal. |
| 3. Horn switch. | 7. Direction indicator. |
| 4. Clutch pedal. | 8. Gear lever. |

Choke or mixture control

To enrich the mixture and assist starting when the engine is cold pull out the knob marked 'C'. The control, when turned half a turn clockwise, will hold in any position, giving a progressively richer mixture as it is pulled out.

On no account should the engine run for any length of time with the knob pulled fully out. It should be returned to the 'off' position (pushed in) as soon as possible as the engine warms up.

The first $\frac{1}{4}$ in. (6.35 mm.) approx. of movement operates only the throttle control. This initial movement can be used to give a fast engine idling speed and prevent stalling when driving at low speeds before the engine has fully warmed up.

Heater and ventilating control

This control provides a means of regulating the heating and ventilating system. Full operating instructions are given on page 11.

CONTROLS AND INSTRUMENTS

Ignition warning light

The ignition warning light serves the dual purpose of reminding the driver to switch off the ignition, and of acting as a no-charge indicator. With the ignition switched on the warning light should only be illuminated when the engine is not running, or is running at a very low speed. As the engine speed increases the light should dim and then go out at a fairly low engine speed.

If the light fails to go out until higher engine speeds are reached or remains alight at all times, inspect the dynamo driving belt for correct tension or breakage. If the belt is in order the charging system must be overhauled by a Distributor or Dealer.

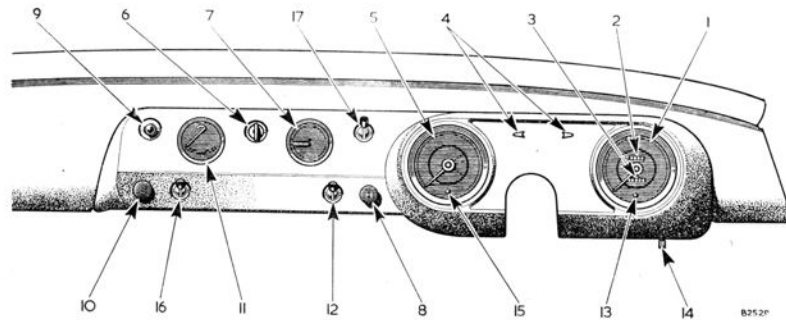

Instruments and switches—right-hand drive

- | | |
|--|--|
| 1. Speedometer. | 9. Windshield washer. |
| 2. Trip mileage indicator. | 10. Choke. |
| 3. Total mileage indicator. | 11. Fuel gauge. |
| 4. Direction indicator warning lights. | 12. Panel light switch. |
| 5. Tachometer. | 13. Headlight main-beam warning light. |
| 6. Ignition and starter switch. | 14. Trip mileage resetting knob. |
| 7. Oil pressure and water temperature gauge. | 15. Ignition warning light. |
| 8. Heater switch. | 16. Windshield wiper switch. |
| | 17. Lighting switch. |

Lighting switch

A lever-type switch. Move the lever downward to the half-way position for the side and tail lights, and into the fully down position for the headlights.

Panel light switch

This is a lever-type switch. The panel lights will only function when the sidelights are switched on.

Fuel gauge

When the ignition is switched on the fuel gauge will indicate the quantity of fuel in the tank. An important note on filling up with fuel is given on page 19.

CONTROLS AND INSTRUMENTS

Oil pressure and water temperature gauge

The pressure of the oil in the engine lubrication system may rise to over 60 lb./sq. in. (4.2 kg./cm.²) when the engine is started up from cold. After the oil has circulated and become warm the pressure should drop to between 30 and 60 lb./sq. in. (2.1 and 4.2 kg./cm.²), with 10 to 25 lb./sq. in. (.7 to 1.7 kg./cm.²) idling pressure. Should the gauge fail to register any pressure at all, stop the engine immediately and investigate the cause.

The temperature gauge indicates the temperature of the coolant leaving the cylinder head. After the initial rise in temperature during the warming up period any sudden upward change in the reading calls for immediate investigation.

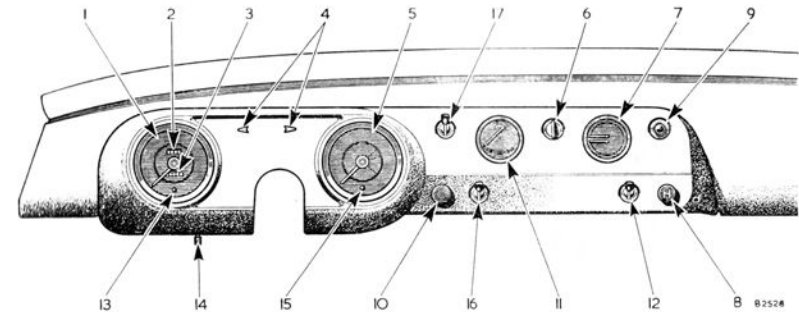

Instruments and switches—left-hand drive

- | | |
|--|--|
| 1. Speedometer. | 9. Windshield washer. |
| 2. Trip mileage indicator. | 10. Choke. |
| 3. Total mileage indicator. | 11. Fuel gauge. |
| 4. Direction indicator warning lights. | 12. Panel light switch. |
| 5. Tachometer. | 13. Headlight main-beam warning light. |
| 6. Ignition and starter switch. | 14. Trip mileage resetting knob. |
| 7. Oil pressure and water temperature gauge. | 15. Ignition warning light. |
| 8. Heater switch. | 16. Windshield wiper switch. |
| | 17. Lighting switch. |

Direction indicators

The direction indicator switch is mounted on an arm on the steering-column below the steering-wheel. The indicators will operate only when the ignition is switched on, and the indicator warning lights in the instrument panel flash when they are in use.

Speedometer

In addition to recording the road speed this instrument also records the trip and total distances. The trip recorder enables the length of a particular journey to be recorded, and can be set to zero by pushing upwards and turning the knob located beneath the instrument.

CONTROLS AND INSTRUMENTS

Tachometer

This instrument indicates the revolutions per minute of the engine, and this assists the driver to use the most effective engine speed range for maximum performance in any gear.

Windshield wiper switch

The two windshield wiper blades are operated by a lever-type switch. Flick down the switch to bring both wiper blades into operation. The blades will park automatically when the knob is flicked up to switch off.

Windshield washer

To operate the windshield washer press the control knob. When following other vehicles, particularly under dirty road conditions, the washer should be operated before the wiper blades are set in motion.

In cold weather the reservoir should be filled with a mixture of water and recommended washer solvent to prevent the water freezing in the reservoir and on the windshield.

Do not use radiator anti-freeze solution in the windshield-washing equipment.

OPTIONAL EXTRAS

The following items of equipment are available as optional extras:

- | | |
|------------------------------------|----------------------------|
| ✓ Wire wheels. | Cigar-lighter. |
| Locking petrol filler cap. | Wing mirror. |
| ✓ White-walled tyres. | Hard top. |
| Nylon cord tyres. | ✓ Heater (fresh-air type). |
| Road Speed tyres. | Fresh-air unit. |
| ✓ Heavy-duty (6-ply rating) tyres. | ✓ Tonneau cover. |
| Windscreen (laminated type). | Twin horns. |
| Luggage grid. | Wheel disc. |
| Rear compartment cushion. | Radio. |
| Fog lamp. | Towing bracket. |
| Anti-roll bar. | Headlight flasher. |

HEATING AND VENTILATING

The heating and ventilating system is designed to provide heated fresh air to the car interior at floor level and to the windshield for demisting and defrosting.

A valve controlling the flow of hot water through the heater unit is fitted at the rear of the cylinder head. The valve is opened by turning in an anti-clockwise direction when heating is required or shut off by turning clockwise when the system is to be used for cool air ventilation.

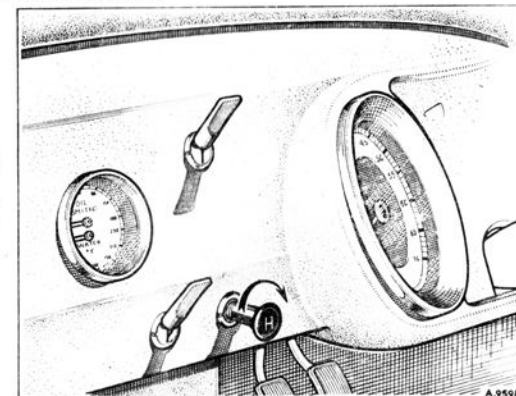

The air blower switch; turn the knob in the direction of the arrow to switch on the motor. Switch off and pull the control out to close the air intake flap

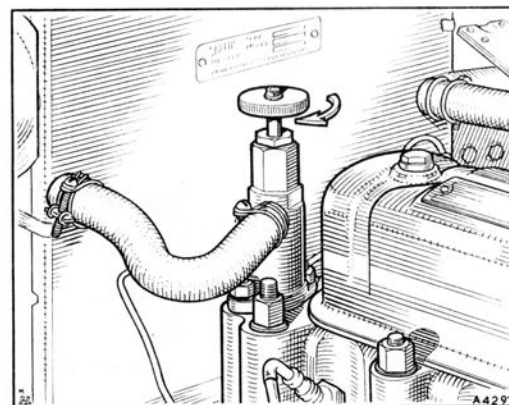

The water valve on the cylinder block; turn the tap in the direction of the arrow to shut off the flow of hot water to the heater

Air is drawn in through a forward-facing intake, and the ram effect caused by the car's motion will provide air for the heater's requirements at speeds above 25 m.p.h. (40 km.p.h.). A blower motor is provided for use at lower speeds or when a greater quantity of air is required. The blower is switched on by turning the control marked 'H' on the fascia in a clockwise direction.

A shut-off valve is incorporated in the air intake to prevent fumes entering the car in traffic and is closed by pulling out the knob marked 'H'. The blower motor must be switched off before the valve is closed and cannot be switched on again until the valve is returned to the open position.

Two doors located forward, one at each side of the gearbox tunnel, control distribution of air between screen and car interior. For heating open the doors. For defrosting (i.e. boosting flow of hot air to screen) close the doors.

BODY DETAILS

Bonnet lock

Unlock the bonnet from the inside of the car by pulling the control knob marked 'B' located below the fascia and on the left-hand side of the gearbox tunnel. Insert a finger under the left-hand front edge of the bonnet and push the safety catch rearwards to release the bonnet and allow it to be lifted into the open position.

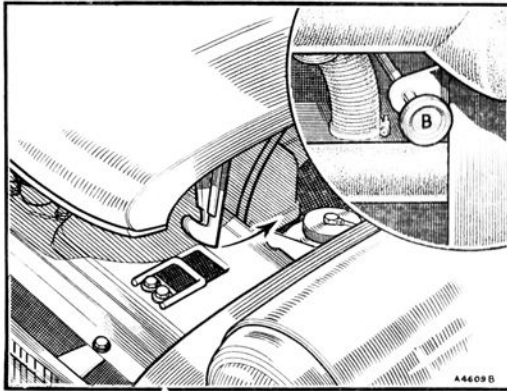

Bonnet lock control and safety catch

The seat-adjusting lever

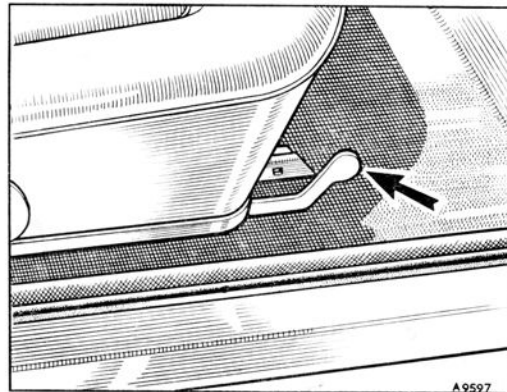

Seat adjustment

The driver's and passenger's seats are mounted on slides and are easily adjustable. Push the lever located beneath the front of the seat to the left to unlock the driver's seat slide and to the right to unlock the passenger's seat slide; hold the lever in this position while the seat is readjusted. The locking pin is spring-loaded and will automatically relock the seat slide when the lever is released.

BODY DETAILS

Doors

Both doors are provided with door-pulls.

A window regulator handle is fitted to the inside of each door.

A draughtproof ventilator panel adjacent to each window may be opened by releasing the catch.

Luggage compartment

Turn the handle in an anti-clockwise direction to release the catch. When closed, turn the handle clockwise to secure.

The lid can be locked in the closed position with the ignition key.

Turn the handle anti-clockwise to open the boot lid. When closed, the lid may be locked with the key provided

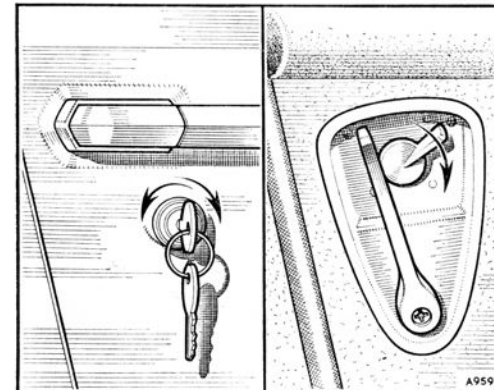
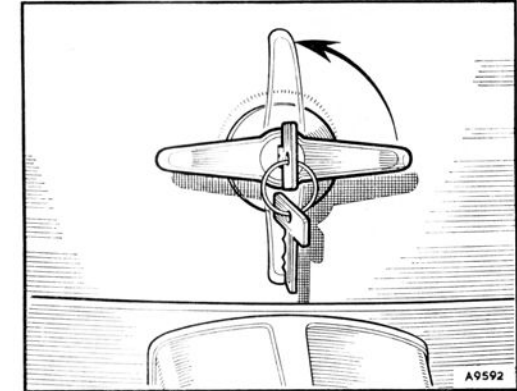

The external and internal door locks

Door locks

Both doors may be locked from the outside with the ignition key. The passenger door may alternatively be locked from inside the car.

To lock the doors turn the key clockwise; to unlock the doors turn the key anti-clockwise.

After locking or unlocking the doors return the key to the vertical position and withdraw it.

The passenger door may be locked from inside the car by turning the locking knob downwards. Turn the knob upwards to unlock the door

BODY DETAILS

Hood

Erecting the hood

Remove the hood from its stowed position (see page 16).

Erect the collapsible frame and pull the front stick forward; leave the rear stick in the collapsed position until the canopy is fitted.

Place the ends of the frame in the support sockets that are fitted one to each rear quarter panel. The long stick faces forward.

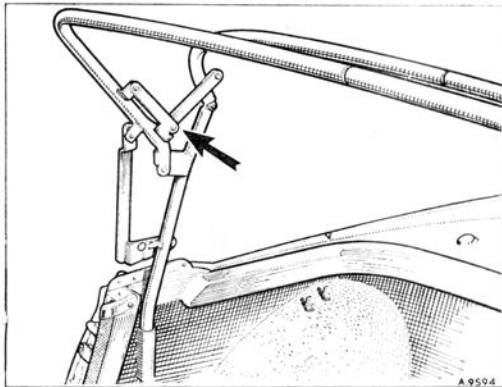

The hood sticks fitted and erected

Extend the rear stick and ensure that the links (one shown arrowed) pass over their centres, inset is the windshield toggle catches

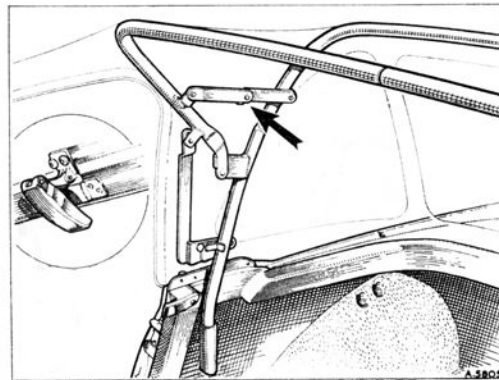

Unfold the hood over the frame and engage the two locating sockets on the lower rear edge of the canopy with the retaining plates on the rear tonneau panel. Engage the fasteners around the rear of the canopy. Secure the hood header rail to the windshield frame with the toggle lever catches and the two fastener assemblies.

Extend the rear stick to tension the canopy and ensure that the connecting links pass over their centres.

BODY DETAILS

Removing the hood

Unlock the over-centre links on the rear stick to slacken the canopy. Undo the fasteners and release the toggle lever catches on the windshield. Release all fasteners around the rear of the hood. Slide the rear hood rail backwards clear of the two slotted fasteners on the tonneau panel, and lift the hood from the frame.

Fold the quarter-lights inwards, folding on a line between the quarter-light and back-light

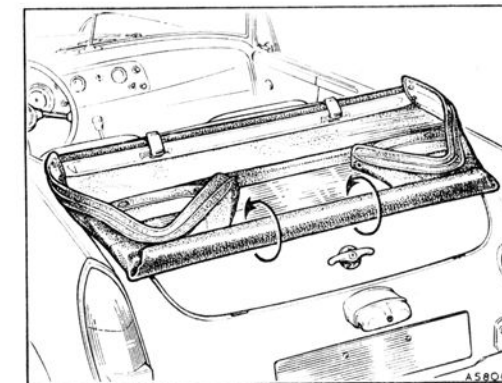
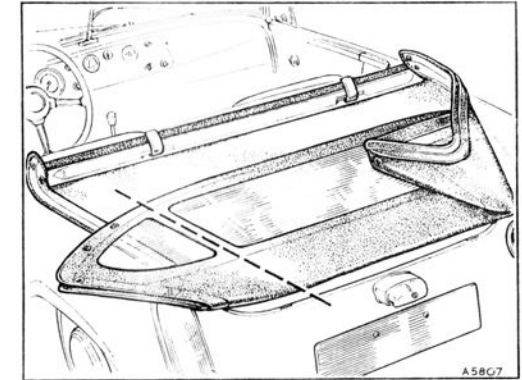

Finally, roll the hood as shown for storage

NOTE.—It is most important that the instructions given should be followed when folding and stowing the hood in order to obviate damage to the quarter- and back-lights. Never fold the hood when it is wet or damp. Wait until it is perfectly dry.

Folding the hood

Folding the hood correctly is of utmost importance; lay the hood on a flat surface with the lining upwards. Fold the hood in the way shown in the illustration and then roll it up carefully, avoiding kinking.

BODY DETAILS

Stowing the hood and hood sticks

Withdraw the frame from the support sockets, fold the sticks and separate the two halves of the frame. Place the canopy and the frame in their respective stowage bags and stow in the luggage compartment.

The hood may suffer damage if stowed without the protection of stowage bag.

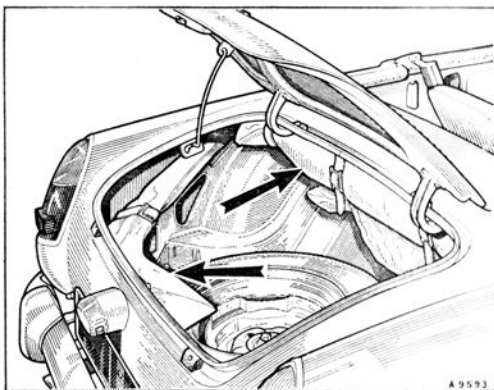

The hood and hood sticks stowed away in the luggage compartment

Tonneau cover

The location of the tonneau cover on the rear body decking is the same as that of the hood. The front section is located on the press studs across the fascia. When driving with only the tonneau cover fitted, the front section can be detached from the top of the fascia and is located on the rear axle body scuttle.

COOLING SYSTEM

A pressurized cooling system is used on this vehicle and the pressure must be released gradually when removing the radiator filler cap while the system is hot. It is advisable to protect the hands against escaping steam and then turn the cap slowly anti-clockwise until the resistance of the safety stop is felt. Leave the cap in this position until all pressure is released. Press the cap downwards against the spring to clear the safety stops and continue turning until it can be lifted off.

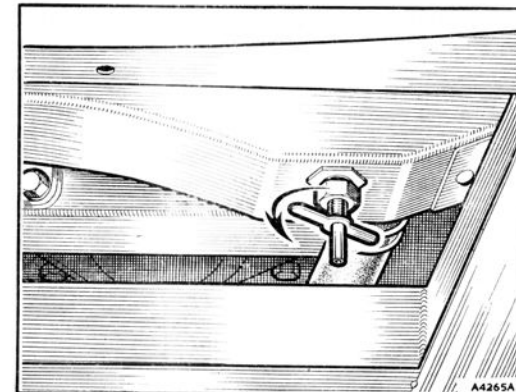

The radiator drain tap on the left-hand side of the radiator bottom tank. Turn in the direction of the arrow to open

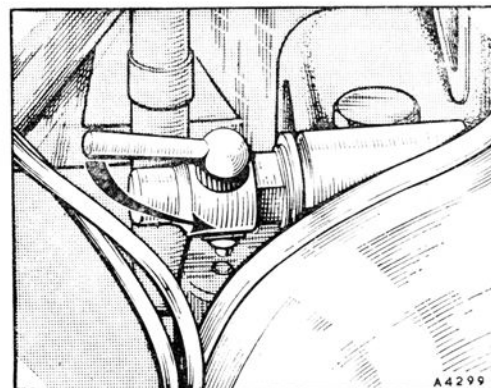

The cylinder block drain tap is on the left-hand side of the block at the rear. Turn in the direction of the arrow to open

Frost precautions

Water, when it freezes, expands, and if precautions are not taken there is considerable risk of bursting the radiator, cylinder block, or heater (where fitted). Such damage may be avoided by draining the cooling system when the vehicle is left for any length of time in frosty weather, or by adding anti-freeze to the water.

Warning

When a heater unit is fitted an anti-freeze solution must be added in the cooling system since no provision is made for draining the heater.

Do not use radiator anti-freeze solution in the windshield-washing equipment (where fitted).

RUNNING INSTRUCTIONS

COOLING SYSTEM

Anti-freeze solutions

Anti-freeze can remain in the cooling system for two years provided that the specific gravity of the coolant is checked periodically and anti-freeze added as necessary. This operation should be carried out by an authorized Distributor or Dealer.

After the second winter the system should be drained and refilled with fresh water, and the appropriate amount of anti-freeze added when required.

Only anti-freeze of the ethylene glycol or glycerine type is suitable for use in the cooling system. We recommend owners to use Bluecol Anti-freeze (non-corrosive) in order to protect the cooling system during frosty weather and reduce corrosion to a minimum. We also approve the use of any anti-freeze which conforms to Specification B.S.3151 or B.S.3152.

The correct quantities of anti-freeze for different degrees of frost resistance are:

Absolute safe limit		Commences freezing at		Solution (%)	Quantity of anti-freeze required
° C.	° F.	° C.	° F.		
-19	-3	-9	16	20	2 pts. (2.4 U.S. pts., 1.1 litres)
-26	-15	-13	9	25	2½ pts. (3.0 U.S. pts., 1.42 litres)
-33	-28	-16	3	30	3 pts. (3.6 U.S. pts., 1.71 litres)

Before adding anti-freeze mixture to the radiator it is advisable to clean out the cooling system thoroughly by flushing out the passages with a hose inserted in the filler cap while keeping the drain taps open.

Only top up when the cooling system is at its normal running temperature, in order to avoid losing anti-freeze due to expansion.

Make sure that the cooling system is water-tight, examine all joints, and replace any defective rubber hose with new.

Draining the cooling system

There are two drain taps provided, one on the radiator bottom tank and the other on the left-hand side of the cylinder block. To drain the coolant stand the car on level ground and open both taps.

When draining in freezing weather, do so when the engine is hot. Run the engine slowly for one minute when the water has ceased flowing to clear any water from the pump and other places where it might collect. Finally, leave a reminder on the vehicle to the effect that the cooling system has been drained.

If the system contains anti-freeze remember to collect it in a clean container for future use.

Filling the cooling system

To avoid wastage by overflow add just sufficient coolant to cover the bottom of the header tank. Run the engine until it is hot and add sufficient coolant to bring the surface to the level of the indicator positioned inside the header tank below the filler neck.

Starting

Before starting the engine ensure that the gear lever is in neutral and the hand brake is applied. If the engine is cold pull out the choke control.

Switch on the ignition, ensure that the ignition warning light glows and that the fuel gauge registers, then operate the starter. Release it if the engine fails to start within five or six seconds, wait for the crankshaft to stop rotating, and then operate the starter again.

Should the engine fail to start after a reasonable number of attempts, check for possible causes. Do not persist in operating the starter as a great strain is imposed on the battery by so doing.

As soon as the engine starts, release the starter and warm up the engine at a fairly fast idling speed. Should the oil gauge fail to register any pressure or if the pressure is very low, stop the engine immediately and investigate the cause. Failure to do so may result in serious damage to the engine. Also check that the ignition warning light goes out when the engine is running above idling speed; failure of the light to behave in this fashion indicates a broken fan belt or other fault in the system.

Push in the choke control completely as soon as the engine will run evenly without its use.

Warming up

Research has proved that the practice of warming up an engine by allowing it to idle slowly is definitely harmful. The correct procedure is to let the engine run fairly fast, approximately 1,000 r.p.m., corresponding to a speed of about 15 m.p.h. (24 km.p.h.) in top gear, so that it attains its correct working temperature as quickly as possible. Allowing the engine to work slowly in a cold state leads to excessive cylinder wear, and far less damage is done by driving the car straight on the road from cold than by letting the engine idle slowly in the garage.

Wet brakes

When the vehicle is being washed or driven through water the brake linings may become wet. To dry them, apply the brakes several times with the vehicle moving slowly. Driving with wet brakes can be dangerous.

Filling up with fuel

When filling up with fuel avoid filling the tank until fuel is visible in the filler intake tube. Should this be done and the car left in the sun, there will be a considerable risk of fuel leakage due to expansion, and consequent danger from exposed fuel. If inadvertently overfilled, take care to park the car in the shade with the filler intake as high as possible.

Running in

The treatment given to a new car will have an important bearing on its subsequent life, and engine speeds during this early period must be limited. The following instructions should be strictly adhered to.

During the first 500 miles (800 km.)

DO NOT exceed 45 m.p.h. (72 km.p.h.).

DO NOT operate at full throttle in any gear.

DO NOT allow the engine to labour in any gear.

RUNNING INSTRUCTIONS

Towing-eyes

If it is necessary to tow a vehicle, use the towing-eyes provided.

High-compression engine (8·9 : 1)

This engine is a highly developed unit and it is essential that you should know something about the specialized maintenance it requires if you are to maintain it at the peak of its mechanical efficiency. Special recommendations on the sparking plugs, ignition settings, and fuel to be used are given by the manufacturers, and it is stressed that failures are bound to occur if these are not strictly adhered to. Particular care is needed with this engine owing to its high compression ratio, which makes it extremely sensitive to variations in fuel, ignition timing, and the heat range of the sparking plugs.

In lower-compression engines a much wider range of fuels can be tolerated without causing serious damage to the engine, and ignition settings will stand variations of a reasonable amount. Also, even if the incorrect sparking plugs are used, no more damage may be incurred than burnt-out plugs or leaky valves. But with an engine having a very high compression ratio the range of fuels, sparking plugs, and ignition settings is much narrower and it is essential that the mixture should always be correct, and particularly never overweak at maximum load or power.

High-compression engines are very sensitive to variations in spark advance (over-advance) and to fuel/air ratio (mixture). Variations in these settings will increase the combustion temperature, and if the variation is excessive pre-ignition will cause high shock waves, resulting in damage to the engine.

The engine should be decarbonized at regular intervals as excessive deposits of ash from the combustion of lubricating oil and fuel can cause pre-ignition difficulties.

Choice of fuel

When fitted with H.C. engine (compression ratio 8·9 : 1)

The octane number of a motor fuel is an indication given by the fuel technicians of its knock resistance. High-octane fuels have been produced to improve the efficiency of engines by allowing them to operate on high compression ratios, resulting in better fuel economy and greater power. Owing to the high compression ratio of the engine, fuels with an octane rating **below 98** are **not** suitable; should it be necessary to use a fuel with a lower octane number, the car must be used very carefully until the correct fuel can be obtained.

It is necessary to use Super grade fuels in the 100-octane range unless premium fuels of minimum 98-octane (Research method) are available.

When fitted with L.C. engine (compression ratio 8·1 : 1)

Premium fuels of minimum 93-octane (Research method) up to 97-octane are required, with preference to 95/97.

Super grade fuels in the 100-octane range can be used if preferred.

IGNITION

Static ignition timing

The point where ignition should start is given in 'GENERAL DATA'. With the crankshaft stationary at this position the contact breaker points should be just beginning to open. When the engine is running timing is varied by a centrifugal advance mechanism and a vacuum control.

Checking static ignition timing

The information given below describes a method of checking the ignition timing; it does not detail the resetting of the timing when the distributor has been removed from the engine.

Check that the contact points are set to the correct gap when on the peak of the distributor cam (see page 46).

The rim of the crankshaft pulley has a small groove which will correspond with the long pointer on the timing cover when Nos. 1 and 4 pistons are at T.D.C.; the other two pointers indicate 5° and 10° B.T.D.C. To turn the pulley

The knurled nut on the distributor illustrated together with the crankshaft pulley groove and timing cover pointers

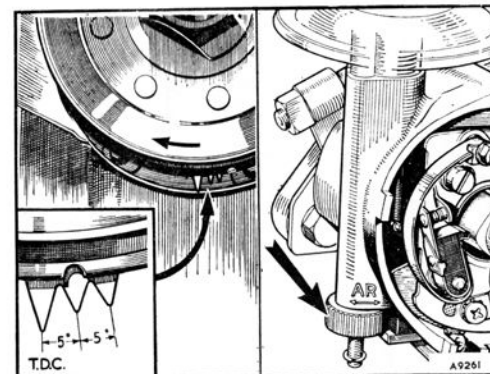

to the required position, remove the sparking plugs, engage top gear, and push the car forward until the groove in the pulley is in the correct position (see 'GENERAL DATA').

With the crankshaft in this position the contact points should be just about to open. If the points are open, turn the knurled nut towards 'R' until they are closed; if they are closed, turn the nut towards 'A'. In both cases turn the nut until the points are just parting.

A simple electrical method may be used to ensure an accurate check. Connect a 12-volt bulb between the low-tension terminal on the side of the distributor and a good earth point on the engine. Switch on the ignition. If the bulb lights, turn the knurled nut towards 'R' until the light goes out and then back towards 'A' until it just lights. This will give the correct static timing.

If this adjustment cannot be made with the knurled nut, consult your Distributor/Dealer.

Battery

The battery electrolyte must be maintained at the correct level.

Remove the manifold weekly and examine the level of the electrolyte in each cell. If necessary, add sufficient distilled water until the perforated separator guard in each cell is just covered. Do not overfill. More frequent topping up may be necessary in hot climates or if long daily runs are made.

Do not use tap-water and do not use a naked light when examining the condition of the cells. Wipe away all dirt and moisture from the top of the battery.

Checking the specific gravity

Check the condition of the battery by taking hydrometer readings of the specific gravity of the electrolyte in each of the cells. Readings should not be taken immediately after topping up the cells. The hydrometer must be held vertically and the readings taken at eye-level. Check that the float is free and take care not to draw in too much electrolyte. The specific gravity readings and their indications are as follows:

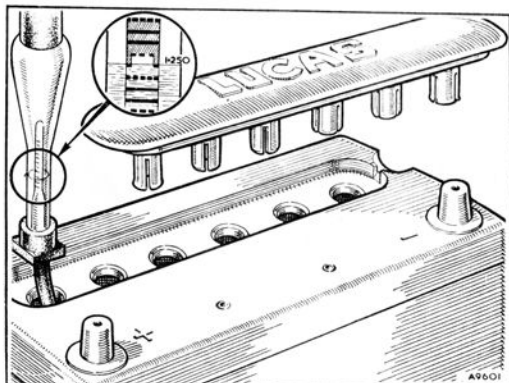

When taking hydrometer readings make certain that the float is free, hold the tube vertically, and do not draw in too much electrolyte. The readings must be taken at eye-level

	For climates below 26.6° C. (80° F.)	For climates above 26.6° C. (80° F.)
Battery fully charged	1.270 to 1.290	1.210 to 1.230
Battery about half-charged ..	1.190 to 1.210	1.130 to 1.150
Battery fully discharged	1.110 to 1.130	1.050 to 1.070

These figures are given assuming that the temperature of the solution is about 16° C. (60° F.). If the temperature of the electrolyte exceeds 16° C. (60° F.) .002 must be added to the hydrometer reading for each 3° C. (5° F.) rise to give the true specific gravity. Similarly, .002 must be subtracted from the hydrometer reading for every 3° C. (5° F.) below 16° C. (60° F.). The readings for all cells should be approximately the same. If one cell gives a reading very different from the rest the battery should be examined by an authorized Distributor or Dealer.

Never leave the battery in a discharged condition for any length of time. Have it fully charged, and every fortnight give it a short refreshing charge to prevent any tendency for the plates to become permanently sulphated.

Voltage regulator

This is a sealed unit, located on the right-hand side of the engine bulkhead under the bonnet, controlling the charging rate of the dynamo in accordance with the needs of the battery. The regulator requires no attention and should not be disturbed.

Fuses

The fuses are housed in a separate fuse block on the engine bulkhead.

The fuse connecting terminals 'A1' and 'A2' protects the accessories that operate irrespective of whether the ignition is on or off.

The fuse connecting terminals 'A3' and 'A4' protects the accessories that operate only when the ignition is switched on (stop lights, direction indicators, etc.).

Regulator and fuse block

1. Regulator cover.
2. AUX.IGN. fuse (35-amp.).
3. Fuse block.
4. AUX. fuse (35-amp.).
5. Spare fuses.

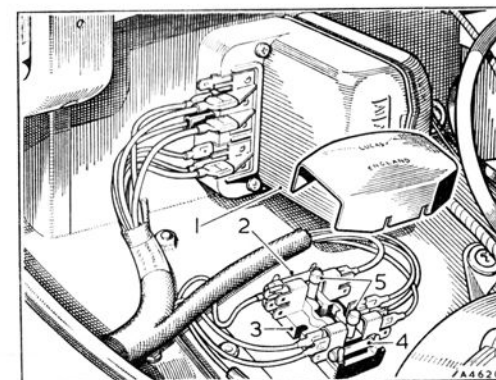

Blown fuses

The units which are protected by the fuses can readily be identified on the wiring diagram. A blown fuse is indicated by the failure of all the units protected by it, and is confirmed by examination of the fuse when withdrawn.

Before renewing a blown fuse inspect the wiring of the units that have failed for evidence of a short circuit or other fault.

Spare fuses are provided and it is important to use only the correct replacement fuse. The fusing value is marked on a coloured paper slip inside the glass tube of the fuse.

Fuel pump

Fuel is delivered to the carburettors by an S.U. electric fuel pump, Type AUF. The pump is situated beneath the luggage compartment on the right-hand side.

Coil

The coil requires no attention beyond keeping its exterior clean, particularly between the terminals, and occasionally checking that the terminal connections are quite tight.

If the high-tension cable needs renewal it must be replaced by the correct type. Bare the end of the cable for ¼ in. (6 mm.), pass it through its moulded terminal and washer, and spread out the strands to ensure good contact.

ELECTRICAL

Jammed starter pinion

In the event of the starter pinion becoming jammed in mesh with the flywheel, it can usually be freed by turning the starter armature with a spanner applied to the shaft extension at the commutator end.

Windshield wiper

Should it be necessary to reposition a wiper arm on the spindle, the arm can be withdrawn when the small spring clip is held clear of the retaining groove. Replace the arm in the required position and push it hard down onto the spindle until it is secured in position by the retaining clip.

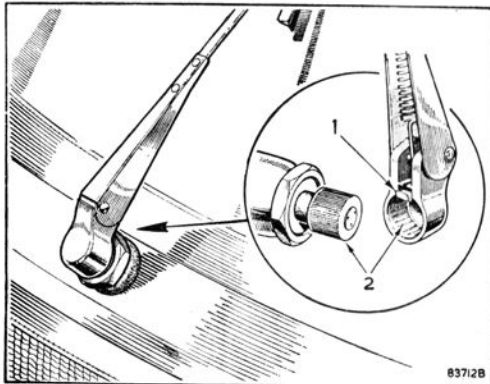

To adjust a wiper blade raise the retaining clip (1) and withdraw the arm. Refit in the desired position on the splined shaft (2)

The headlamp light unit removed, showing the bulb holder and back-shell, etc., with the European-type lamp inset

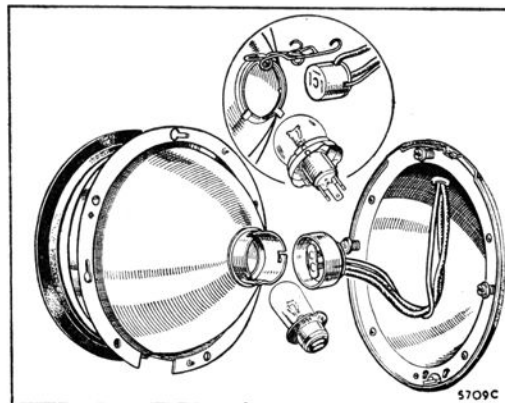

Headlamps (except European and sealed-beam types)

To renew the headlamp bulb, remove the screw from beneath the headlamp and withdraw the rim; push the lamp reflector and glass assembly inwards against the springs, turn it anti-clockwise until the locating screws register with the enlarged ends of the slots, and withdraw the light unit. Depress the back-shell and turn it to release the bulb. When replacing the bulb ensure that the slot in the bulb flange engages the keyway in the holder.

ELECTRICAL

Refit the light unit by positioning it so that the heads of the adjusting screws pass through the slotted holes in the flange, press the unit inwards, and turn it clockwise as far as it will go.

Replace the dust-excluding rubber and refit the rim, locking it in position with the retaining screw.

Headlamps (European type)

The headlamps are fitted with special lenses and bulbs giving an asymmetrical light beam.

The lamp rims are fitted with rubber dust excluders and rim retaining screws. These rims can be removed by releasing the retaining screw at the bottom of the lamp rim. The bulb is released from the reflector by withdrawing the three-pin socket and pinching the two ends of the wire retaining clip to clear the bulb flange. When replacing the bulb care must be taken to see that the rectangular pip on the bulb flange engages the slot in the reflector seating. Replace the spring clip with its coils resting in the base of the bulb flange and engaging the two retaining lugs on the reflector seating for the bulb.

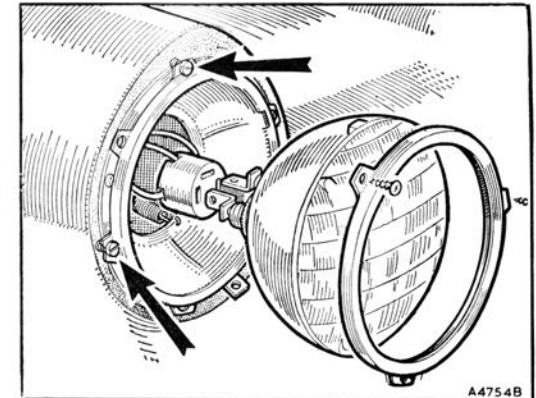

The U.K. sealed-beam headlamp with the beam-adjusting screws indicated by the arrows

Headlamps (U.K. sealed-beam type)

To change a sealed-beam light unit remove the lamp rim by releasing the rim retaining screw at the bottom of the rim assembly. Remove the three retaining screws securing the inner light rim and remove the rim assembly. Pull the unit forward and disconnect the three-pin socket to release it from the back-shell.

Headlamps (North American sealed-beam type)

To change a sealed-beam light unit remove the retaining screw from the bottom face of the lamp rim, lift the bottom of the rim forwards and upwards, and detach the rim. Slacken the three Phillips screws securing the light unit retaining rim and turn the rim anti-clockwise to remove, supporting the lens of the light unit at the same time. Pull off the three-pin plug from the rear of the light unit.

The light unit must be renewed when necessary as a complete assembly.

Setting the headlight beams

The headlight beams must be set so that the main driving beams are straight ahead and parallel with the road surface and with each other, or in accordance

ELECTRICAL

with the local regulations. To adjust, remove the lamp rim and set each lamp to the correct position in the vertical plane by turning the adjusting screw at the top of the light unit in a clockwise direction to raise and anti-clockwise to lower the beam. Horizontal adjustment is made by turning the adjustment screw on each side of the light unit. On the sealed-beam type of light unit there is only one horizontal adjustment screw.

Remember that the setting of the beams is affected by the load on the car and the consequent spring deflection. The lamps should therefore always be set with the normal load on the car.

Avoid setting the main beams above horizontal; they will dazzle oncoming traffic and give inferior road illumination.

Checking and resetting should be carried out at the beginning of each winter. This work is best entrusted to a Distributor/Dealer, who will have specialist equipment available for this purpose.

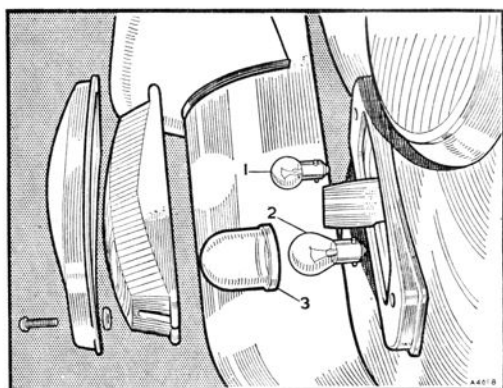

The side and direction indicator lamp

1. Sidelamp bulb.
2. Direction indicator bulb.
3. Amber direction indicator bulb cover.

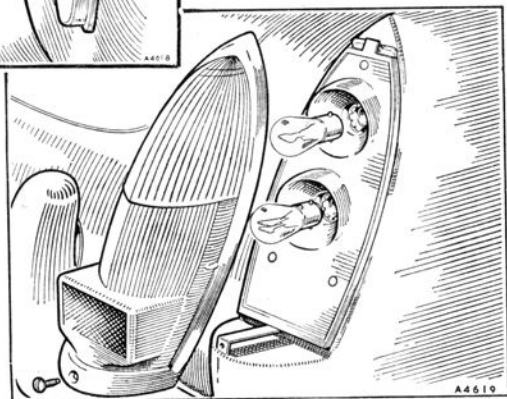

The stop, tail, and direction indicator lamp

Side and direction indicator lamps

Extract the two retaining screws to release the plated rim and the lens to gain access to both the light and direction indicator bulbs. An amber cover is fitted over the direction indicator bulb when the vehicle is operating in countries where the lighting regulations require amber flashing indicators.

ELECTRICAL

Stop and tail and direction indicator lamps

Extract the one retaining screw from the bottom of the lamp and slide the lens upwards to release it from the retaining tongue at the top of the lamp.

Number-plate lamp

The number-plate light is switched on with the sidelights and tail lights. Access to the bulbs is obtained by unscrewing the one slotted screw and removing the domed cover and glass.

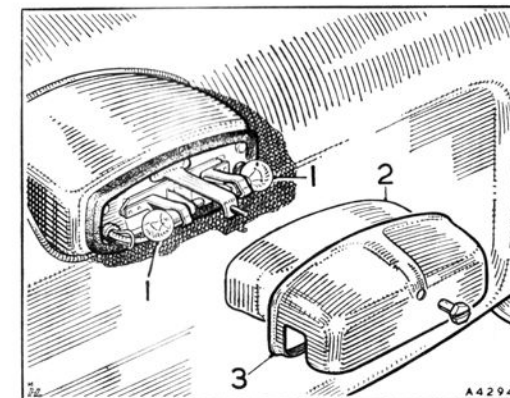

Rear number-plate lamp

1. Bulbs.
2. Glass.
3. Cover.

Panel and warning lights

The panel and warning lights are located in the position shown in the illustration above. All the bulb holders are a push fit in the sockets and can be pulled from their fixings at the back of the instrument panel to enable a defective bulb to be replaced.

Replacement bulbs

	Volts	Watts	B.M.C. Part No.
Headlamp, L.H.D. (except North America and Europe)	12	50/40	BFS 415
Headlamp (Europe except France)	12	45/40	BFS 410
Headlamp (France only)	12	45/40	BFS 411
Sidelamp	12	6	BFS 989
Sidelamp, direction indicator (North America and Italy)	12	6/21	BFS 380
Direction indicator, front	12	21	BFS 382
Direction indicator, rear	12	21	BFS 382
Tail and stop lamp	12	6/21	BFS 380
Number-plate illumination lamp	12	6	BFS 989
Panel and warning lights	12	2.2	BFS 987

WIRING DIAGRAM

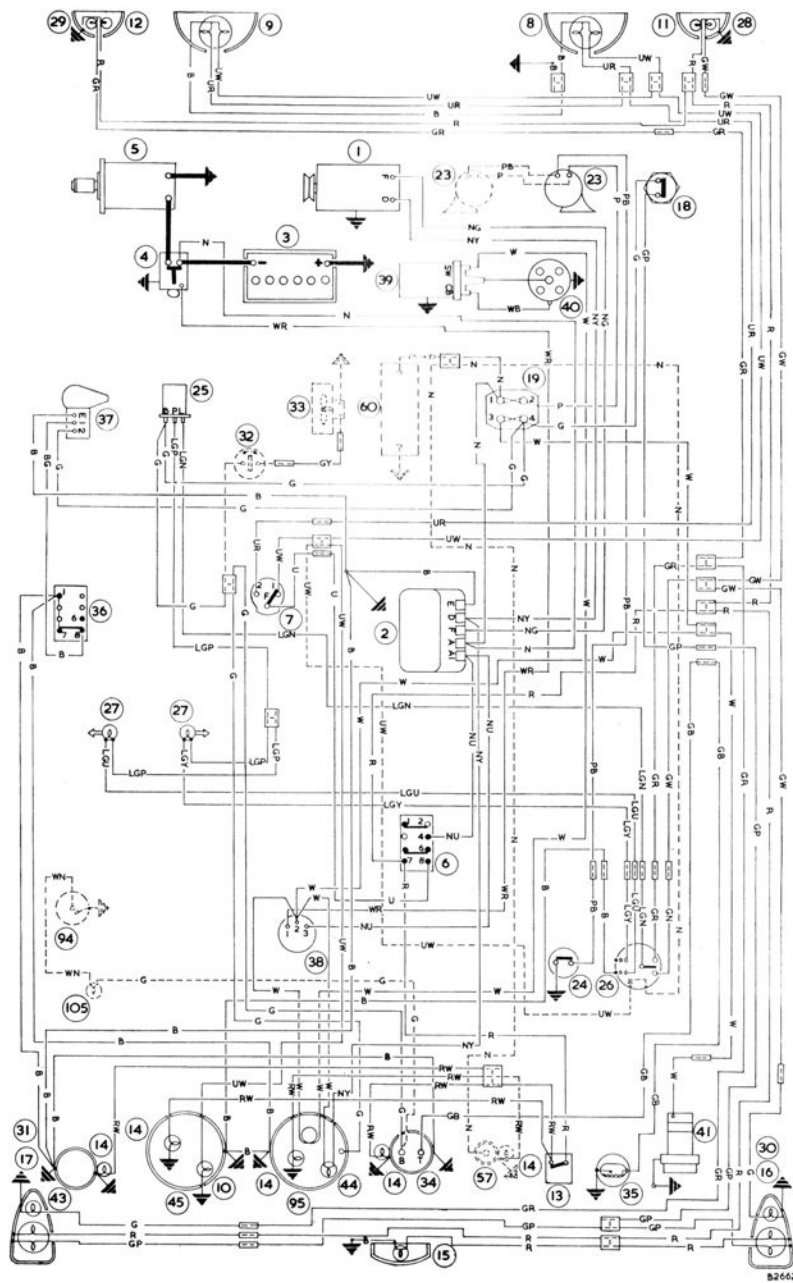

KEY TO WIRING DIAGRAM

1. Dynamo.
2. Control box.
3. Battery (12-volt).
4. Starter solenoid.
5. Starter motor.
6. Lighting switch.
7. Headlight dip switch.
8. R.H. headlamp.
9. L.H. headlamp.
10. Main-beam warning light.
11. R.H. sidelamp.
12. L.H. sidelamp.
13. Panel light switch.
14. Number-plate illumination lamp.
15. R.H. stop and tail lamp.
16. L.H. stop and tail lamp.
17. Stop light switch.
18. Fuse unit (35 amps.).
19. Horn (twin horns when fitted).
20. Horn-push.
21. Flasher unit.
22. Direction indicator switch.
23. Direction indicator warning lights.
24. R.H. front flasher lamp.
25. L.H. front flasher lamp.
26. R.H. rear flasher lamp.
27. L.H. rear flasher lamp.
28. Heater or fresh-air motor switch (when fitted).
29. Heater or fresh-air motor (when fitted).
30. Fuel gauge.
31. Fuel gauge tank unit.
32. Windshield wiper switch.
33. Windshield wiper motor.
34. Ignition/starter switch.
35. Ignition coil.
36. Distributor.
37. Fuel pump.
38. Oil pressure gauge.
39. Ignition warning light.
40. Speedometer.
41. Cigar lighter (illuminated).
42. Radio.
43. Oil filter switch (when fitted—later cars only).
44. Tachometer (impulse—later cars only).
45. Lubrication warning light (when fitted).

CABLE COLOUR CODE

N. Brown.	P. Purple.	W. White.
U. Blue.	G. Green.	Y. Yellow.
R. Red.	L.G. Light Green.	B. Black.

When a cable has two colour code letters the first denotes the main colour and the second denotes the tracer colour.

WHEELS AND TYRES

Jacking up the car

The jack is designed to lift one side of the car at a time. Apply the hand brake, and if the car is on an incline it is advisable to scotch one of the wheels on the opposite side of the car to the one being jacked.

Remove the plug from the jacking socket located in the door sill panel and insert the lifting arm of the jack into the socket. Remove the hub cover and slacken the road wheel nuts. **Make certain that the jack lifting arm is pushed fully into the socket and that the base of the jack is on firm ground.** The jack should lean slightly outwards at the top to allow for the radial movement of the car as it is raised.

Jacking position. Make certain that the jack lifting arm is fully inserted in the socket and that the jack base is firmly positioned immediately below this socket

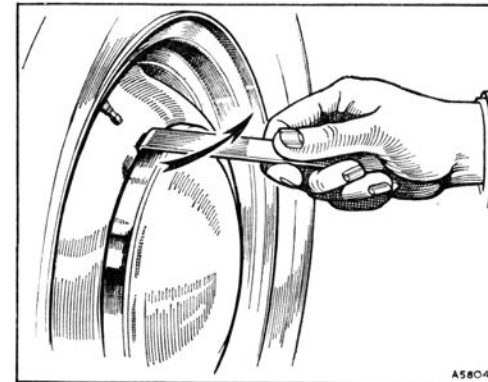
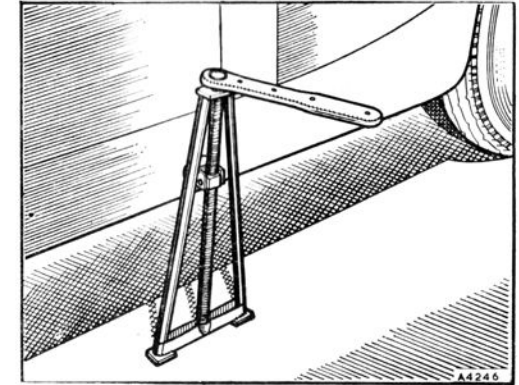

Insert the end of the hub cover lever behind the disc and use a twisting movement to remove the hub cover

Jack maintenance

If the jack is neglected it may be difficult to use in a roadside emergency. Examine it occasionally, clean off accumulated dust, and lightly oil the thread to prevent the formation of rust.

Removing the wheel discs (pressed-steel wheels)

Insert the wheel disc lever in the recess provided in the road wheel and lever off the disc, using a sideways motion.

To refit the hub disc, place the rim over two of the buttons on the wheel centre and give the outer face a sharp blow with the hand over the third button.

WHEELS AND TYRES

Removing and replacing the wheels (pressed type)

Slacken the four nuts securing the road wheel to the hub; turn anti-clockwise to loosen and clockwise to tighten. Raise the car with the jack (page 31) to lift the wheel clear of the ground and remove the nuts. Withdraw the road wheel from the hub. When refitting the road wheel locate the wheel on the hub, lightly tighten the nuts with the wheel nut spanner (securing nuts must be fitted with the **taper side towards the wheel**), and lower the jack. Fully tighten the wheel nuts, tightening them diagonally and progressively, at the same time avoid over-tightening.

Replace the hub cover and jack socket plug.

Removing and replacing the wheels (wire type)

Use the mallet to slacken the winged hub nut or the spanner to slacken the octagonal hub nut used.

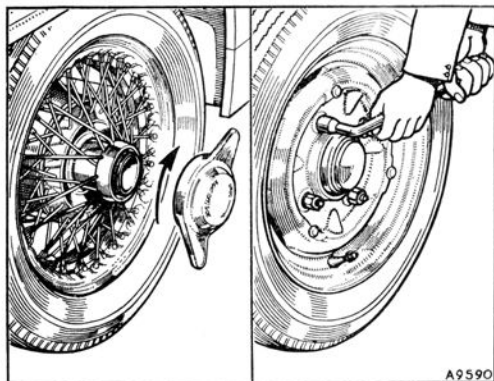

(Left) Turn the winged hub nuts clockwise to unscrew on the right-hand side of the car and anti-clockwise on the left-hand side

(Right) Removing the road wheel securing nuts (pressed type)

Care of wire wheels

- (1) When the car is new, after the first long run or after 50 miles (80 km.) of short runs, jack up the wheels and hammer the nuts to make sure that they are tight.
- (2) Always jack up a wheel before using the hammer, and always hammer the nuts tight.
- (3) Locknuts are marked 'LEFT' or 'RIGHT' to show to which side of the car they must be fitted, and also with the word 'UNDO' and an arrow.
- (4) Before replacing a wheel wipe all serrations, threads, and cones of the wheel and hub and then lightly coat them with grease. If a forced change is made on the road, remove, clean, and grease as soon as convenient.
- (5) Once a year remove the wheels for examination and regreasing.

WHEELS AND TYRES

Tyre maintenance

To obtain the best tyre mileage and to suppress the development of irregular wear on the tyres the wheels can be interchanged diagonally bringing the spare wheel into use.

Excessive local distortion as a result of striking a kerb, a loose brick, a deep pot-hole, etc., may cause the casing cords to fracture.

Tyres must be maintained at the pressures recommended on page 4; check with an accurate tyre gauge at least once a week, and regulate as necessary. Pressures should be checked when the tyres are cold; do not reduce the pressure in warm tyres where the increase above the normal pressure is due to temperature.

Regular attention must also be given to the spare wheel.

See that the valve caps are screwed down firmly by hand. The cap prevents the entry of dirt into the valve mechanism and forms an additional seal on the valve, preventing any leakage if the valve core is damaged.

Flints and other sharp objects should be removed with a penknife or similar tool. If neglected, they may work through the cover.

A section through a tubeless tyre, showing (1) the air retaining liner, (2) the rubber air seal, (3) the rubber-sealed valve

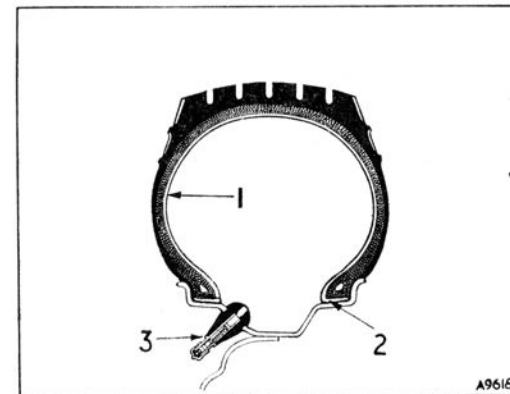

Any oil or grease which may get onto the tyres should be cleaned off by using fuel sparingly. Do not use paraffin (kerosene), which has a detrimental effect on rubber.

With tubeless tyres penetration does not normally result in deflation and the tyres should be repaired when convenient. Penetrations by objects of small diameter can be repaired with the tyre manufacturer's plugging kit, while more extensive damage requires the removal of the tyre for vulcanizing.

When repairing tubes have punctures or injuries vulcanized. Ordinary patches should only be used for emergencies.

Vulcanizing is absolutely essential in the case of tubes manufactured from synthetic rubber.

WHEELS AND TYRES

Tyre removal and refitting

Removal and replacement procedure for tubeless tyres is similar to that used for tyres with inner tubes.

Remove the valve interior to deflate the tyre completely and push both cover edges into the base of the rim at the point diametrically opposite to the valve, then lever the cover edge near the valve over the rim edge. Continue round the tyre until the bead on one side is completely free. Stand the tyre and wheel

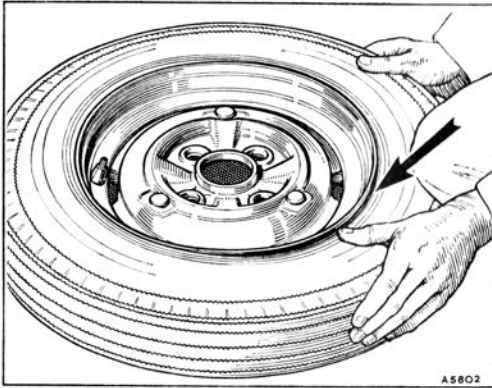

The cover bead must be pushed into the well-base of the wheel rim, as indicated by the arrow

The cover edge must be levered over the rim close to the valve to remove or refit the tyre

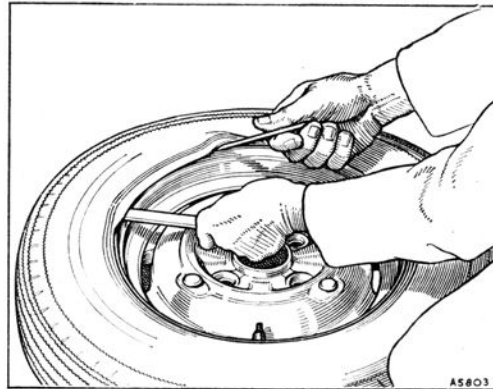

upright, keeping the remaining bead in the well-base of the wheel rim. Lever the tyre bead at the top of the wheel over the rim edge, and at the same time push the wheel away from the cover with the other hand.

A similar technique has to be employed when replacing the tyre, keeping the beaded edge in the well-base of the wheel rim and carefully levering the tyre edge over the wheel rim on the opposite side. Great care must be exercised to avoid damage to the tyre bead and the tyre levers used must be in good condition.

Initial inflation can be carried out with a foot pump, using a rope tourniquet around the periphery of the tyre to obtain a seal between the tyre edge and the wheel rim, but it is more easily accomplished with a compressed-air line.

LUBRICATION DIAGRAM

KEY TO LUBRICATION DIAGRAM

DAILY

- (1) ENGINE. Inspect the oil level, and top up if necessary with oil to Ref. A.

EVERY 3,000 MILES (5000 Km.)

- (2) STEERING TIE-ROD BALL JOINTS (2 nipples). Give three or four strokes of a gun filled with grease to Ref. C.
- (3) SWIVEL AXLES AND SUSPENSION LOWER JOINTS (6 nipples). Give three or four strokes of a gun filled with grease to Ref. C.
- (4) PROPELLER SHAFT (2 nipples). Give three or four strokes of a gun filled with grease to Ref. C.
- (5) HAND BRAKE CABLE (1 nipple). Give three or four strokes of a gun filled with grease to Ref. C.
- (6) HAND BRAKE COMPENSATOR LEVER (1 nipple). Give three or four strokes of a gun filled with grease to Ref. C.
- (7) CARBURETTORS. Top up damper assembly reservoirs with oil to Ref. A.

NOTE.—The engine oil change periods are those recommended when a multigrade oil is used. Monograde or single viscosity oil should be changed at 3,000 mile intervals.

EVERY 6,000 MILES (10000 Km.)

- (8) ENGINE. Drain off the old oil and refill with fresh oil to Ref. A.
- (9) GEARBOX. Top up if necessary to the filler plug level with oil to Ref. A.
- (10) REAR AXLE. Top up if necessary to the filler plug level with oil to Ref. B.
- (11) DISTRIBUTOR. Lubricate all parts as necessary.
- (12) OIL FILTER. Wash the bowl in fuel and fit a new element.
- (13) DYNAMO. Add a few drops of oil to Ref. A through the oil hole in the commutator end bearing.

EVERY 12,000 MILES (20000 Km.)

- (14) STEERING-RACK. Apply the grease gun filled with oil to Ref. B to the nipple on the steering rack and give 10 strokes only.
- (15) WATER PUMP. Remove the plug and add grease to Ref. C; replace the plug.

NOTE.—Oil and grease references are to be found on page 68.

LUBRICATION DIAGRAM

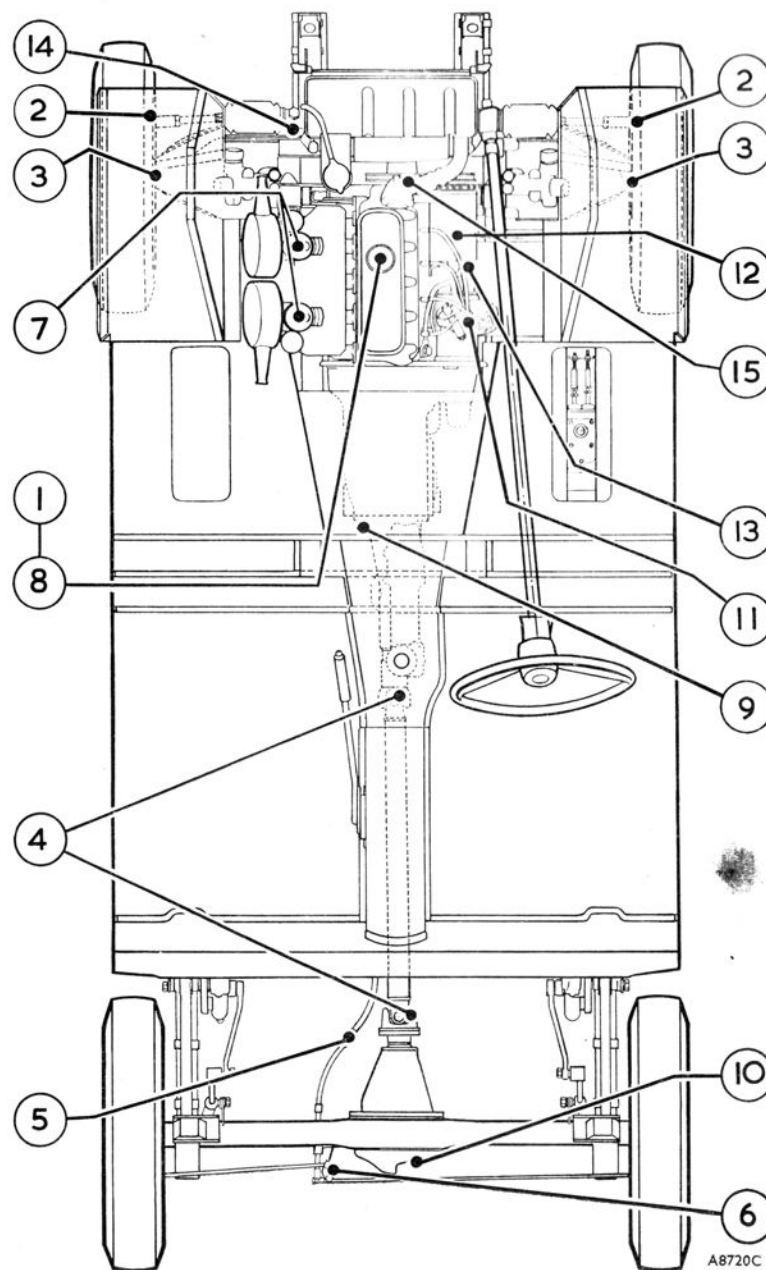

CARBURETTER ADJUSTMENTS

Slow-running adjustment and synchronization

When the engine is fully run in the slow running may require adjustment. This must only be carried out when the engine has reached its normal running temperature.

As the needle size is determined during engine development, tuning of the carburetters is confined to correct idling setting. Slacken the actuating arms on the throttle spindle interconnection. Close both throttles fully by unscrewing the throttle adjusting screws, then open each throttle by screwing down each idling adjustment screw one turn.

Remove the pistons and suction chambers, and disconnect the choke control cable. Screw the jet adjusting nuts until each jet is flush with the bridge of its carburetter, or as near to this as possible (both jets being in the same relative position to the bridge of their respective carburetters). Replace the pistons and suction chamber assemblies, and check that the pistons fall freely onto the bridge of the carburetters (by means of the piston lifting pins). Turn down each jet adjusting nut two complete turns (12 flats).

The Type HS2 carburetter, showing:

1. Throttle adjusting screw.
2. Butterfly operating fork.
3. Fast-idle adjusting screw.
4. Jet link securing screw.
5. Jet locking nut.
6. Flat-chamber securing nut.
7. Jet adjusting nut.

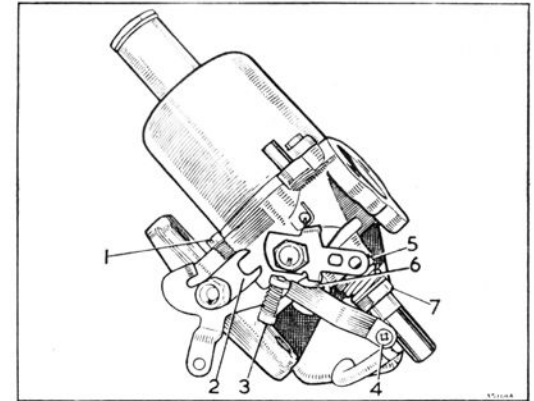

Restart the engine, and turn the throttle adjusting screws to give the desired idling speed by moving each screw an equal amount. By listening to the hiss in the intakes, adjust the throttle adjusting screws until the intensity of the hiss is similar on both intakes. This will synchronize the throttles.

When this is satisfactory, the mixture should be adjusted by screwing each jet adjusting nut up or down by the same amount until the fastest idling speed is obtained consistent with even firing. During this adjustment it is necessary to press the jets upwards and ensure that they are in contact with the adjusting nuts.

As the mixture is adjusted the engine will probably run faster and it may therefore be necessary to unscrew the throttle adjusting screws a little, each by the same amount, to reduce the speed.

Now check the mixture strength by lifting the piston of the front carburetter by approximately $\frac{1}{32}$ in. (.75 mm.) when:

- (1) If the engine speed increases, the mixture strength of the front carburetter is too rich.

CARBURETTER ADJUSTMENTS

- (2) If the engine speed immediately decreases, the mixture strength of the front carburetter is too weak.
- (3) If the engine speed momentarily increases very slightly, the mixture strength of the front carburetter is correct.

Repeat the operation at the rear carburetter, and after adjustment re-check the front carburetter, since both carburetters are interdependent.

When the mixture is correct the exhaust note should be regular and even. If it is irregular, with a splashy type of misfire and colourless exhaust, the mixture is too weak. If there is a regular or rhythmical type of misfire in the exhaust beat, together with a blackish exhaust, then the mixture is too rich.

Throttle linkage

Each throttle is operated by a lever and pin, with the pin working in a forked lever attached to the throttle spindle. A clearance exists between the pin and fork which must be maintained when the throttle is closed and the engine idling to prevent any load from the accelerator linkage being transferred to the throttle butterfly and spindle.

To set this clearance, with the throttle shaft levers free on the throttle shaft put a .012 in. (.305 mm.) feeler between the throttle shaft stop at the top and the carburetter heat shield. Move the throttle shaft lever downwards until the lever pin rests lightly on the lower arm of the fork in the carburetter throttle lever. Tighten the clamp bolt of the throttle shaft lever at this position. When both carburetters have been dealt with, remove the feeler. The pins on the throttle shaft should then have clearance in the forks.

Reconnect the choke cable, ensuring that the jet heads return against the lower face of the jet adjusting nuts when the choke control is pushed fully in. Pull out the mixture control knob on the dash panel to its maximum extent without moving the carburetter jets—about $\frac{5}{8}$ in. (16 mm.)—and adjust the fast-idle cam screws to give an engine speed of about 1,000 r.p.m. when hot.

PERIODICAL MAINTENANCE

DAILY

Radiator

Check the water level in the radiator and top up if necessary.

Engine

Check the level of the oil in the engine sump, and top up if necessary to the 'MAX' or 'FULL' mark on the dipstick.

Clean, fresh oil is essential, and the use of an oil to Ref. A (page 68) is recommended.

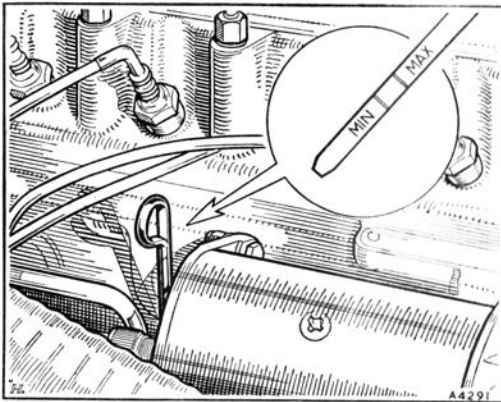

The engine oil dipstick with the level markings shown inset

The oil filler cap on the forward end of the cylinder head cover. Turn the cap anti-clockwise to release it

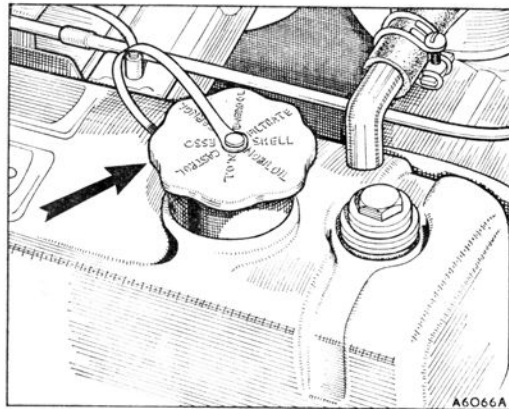

WEEKLY

Tyres

Check all tyre pressures (see page 33), and inflate if necessary to the recommended pressures. See page 4 for correct pressures.

Battery

Remove the filler plugs and examine the level of the electrolyte in each cell (see page 22).

EVERY 3,000 MILES (5000 Km.)

Carburettors

Each damper reservoir must be topped up periodically with thin engine oil to Ref. A (page 68). Under no circumstances should heavy-bodied lubricant be used. Unscrew the damper cap, withdraw the damper, and top up the reservoir until the oil level is $\frac{1}{2}$ in. (12 mm.) below the top of the hollow piston rod. Push the damper assembly back into position and screw the cap firmly into the reservoir.

Apply a few spots of oil to the throttle control linkage joints.

Lubricating the carburettor piston dampers

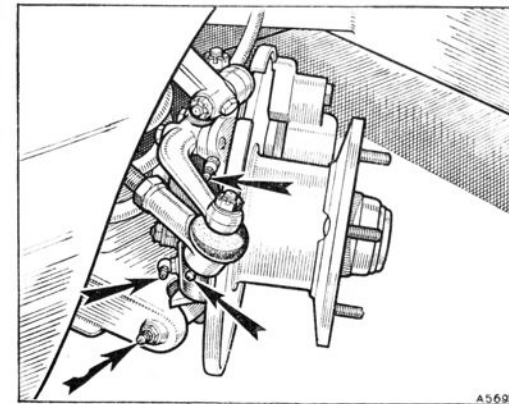
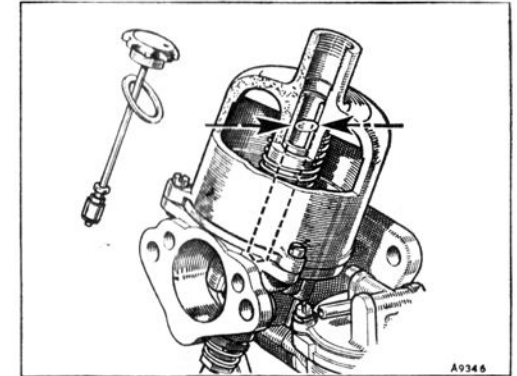

Front suspension and steering connection lubricating points

Swivel axle pins

Two nipples each side—several strokes of the gun filled with lubricant to Ref. C (page 68)—this operation is best carried out with the vehicle partly jacked up to allow the lubricant to penetrate properly around the bushes.

Front suspension outer fulcrum pins

One nipple each side—several strokes of the gun filled with lubricant to Ref. C (page 68).

Steering connections

One nipple each side located on the tie-rod ball joint—several strokes of the gun filled with lubricant to Ref. C (page 68).

EVERY 3,000 MILES (5000 Km.)

Propeller shaft universal joints

One nipple at each end of the shaft. Lift the floor covering and remove the rubber plug in the propeller shaft tunnel to gain access to the nipple on the forward end of the shaft. The nipple on the rear universal joint is accessible from beneath the car. Move the vehicle to gain access to the nipples (use **grease** to Ref. C [page 68]).

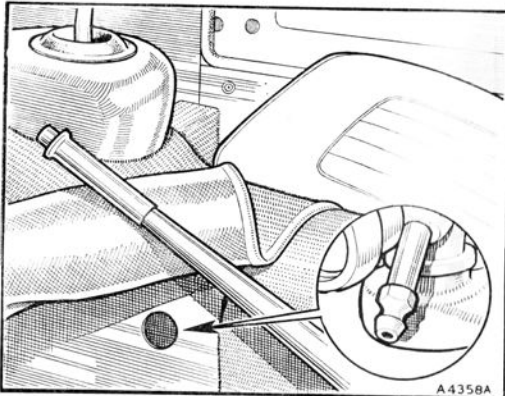

Propeller shaft front universal joint nipple accessible when the rubber plug is removed from the propeller shaft tunnel

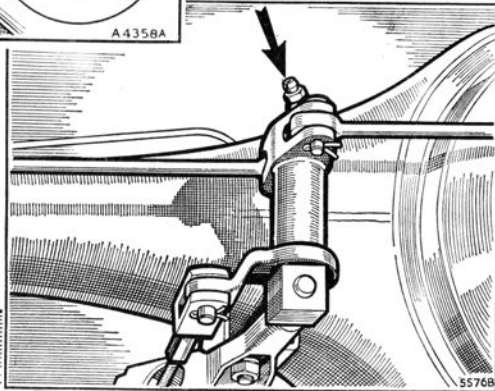

The rear brake balance lever lubricating nipple

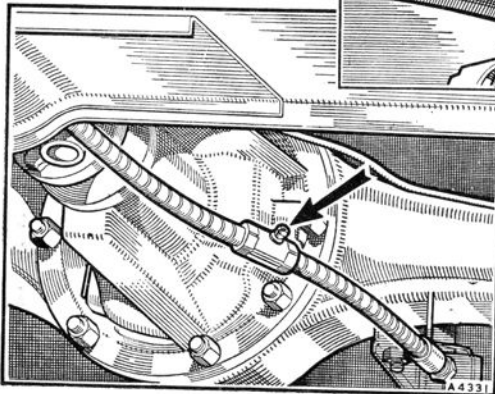

Hand brake cable lubricating nipple

Brakes

One nipple on the balance lever mounted on the rear axle and one on the cable located just forward of the axle (use **grease** to Ref. C [page 68]).

EVERY 3,000 MILES (5000 Km.)

Brake and clutch master cylinder

Check the fluid level in the hydraulic brake and clutch master cylinder and replenish if necessary with **LOCKHEED DISC BRAKE FLUID (Series II)**. Do not use any substitute as this will seriously affect the working of the system.

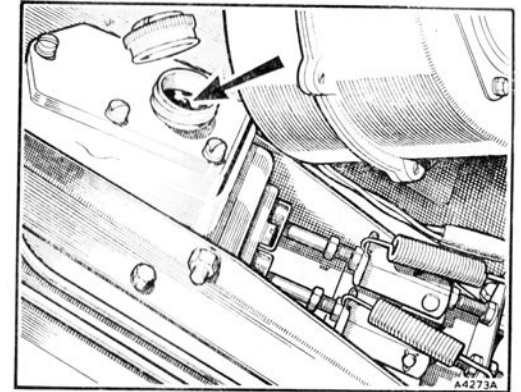

The level of the fluid in the hydraulic brake and clutch master cylinder should be maintained at $\frac{1}{4}$ in. (6.5 mm.) below the bottom of the filler neck

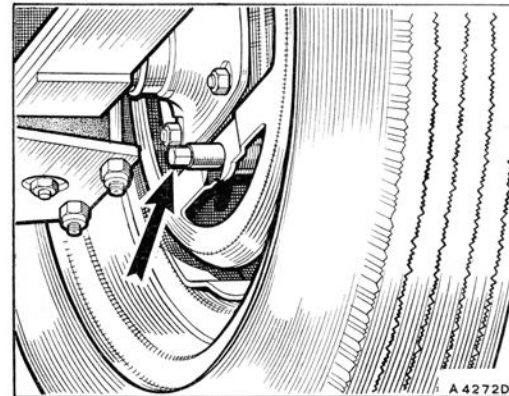

One square-headed brake adjusting bolt is provided on each rear brake-plate

Rear brakes

Check the operation of the brakes; if necessary, adjust as follows.

Chock the wheels remaining in contact with the ground to prevent the car rolling, and use the special jack provided to raise each side of the car in turn.

The square-headed bolt on the brake-plate adjusts both brake-shoes. To move the shoes nearer to the drums turn the adjusting bolt in a clockwise direction (viewed from the centre of the car) a quarter of a turn at a time. Turn the bolt until a definite resistance is felt, and then slacken back a quarter of a turn or more until the wheel rotates without binding.

For the complete summary of attention to be given every 3,000 miles (5000 km.) refer to page 52.

EVERY 6,000 MILES (10000 Km.)

Gearbox

Check the oil level, and top up if necessary. To reach the combined filler and level plug lift the floor covering on the left-hand side of the gearbox and remove the rubber plug from the side of the gearbox cover. Clean around the filler plug before removing it. Top up to the bottom of the threads in the filler plug aperture with oil to Ref. A (page 68).

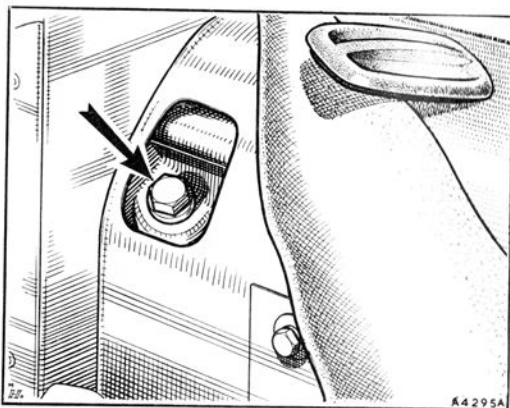

The gearbox combined oil filler and level plug

The rear axle filler and level plug

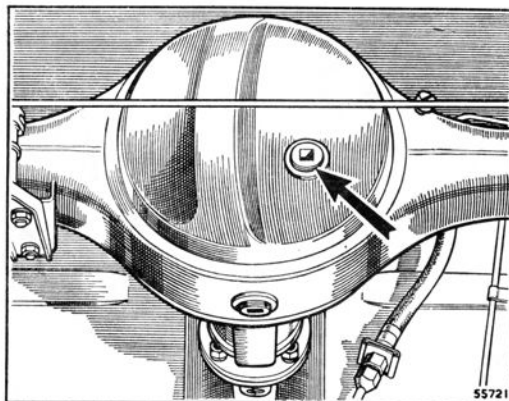

Rear axle

Check the level, and top up if necessary with oil to Ref. B (page 68). The filler plug is located on the rear of the axle and also serves as an oil level indicator.

After topping up allow time for any surplus oil to run out if too much has been injected. This is most important, as if the axle is overfilled the lubricant may leak through to the brake linings and impair their efficiency.

EVERY 6,000 MILES (10000 Km.)

Draining the engine sump

The sump should be drained to clear it of any impurities that may have accumulated and then refilled with the appropriate grade of lubricant. Do this immediately the car returns from a journey, while the oil is still warm and fluid. The drain plug will be found at the rear right-hand extremity of the sump, and care should be taken to ensure that no dirt or grit enters the sump while the plug is removed or when it is being refitted. The plug must be cleaned thoroughly before fitting and screwed up tightly.

Refill the sump with fresh oil to Ref. A (page 68).

The oil drain pipe situated on the right-hand side of the engine sump

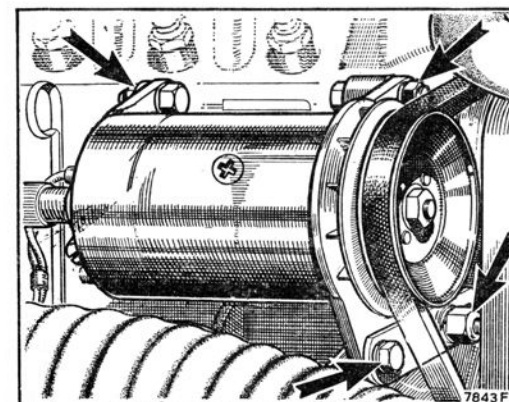
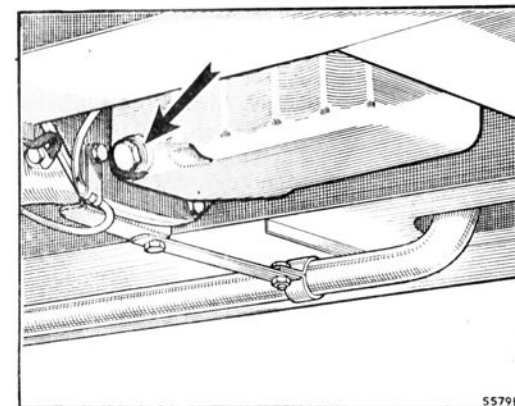

The four points of adjustment for the dynamo, all of which must be slackened for belt adjustment

Fan belt

Inspect the fan belt, and adjust if necessary to take up any slackness. Care should be taken to avoid overtightening the belt, otherwise undue strain will be thrown on the dynamo bearings. The belt tension is adjusted by slackening the bolts of the dynamo cradle and moving the dynamo the required amount by hand. Tighten up the bolts thoroughly.

EVERY 6,000 MILES (10000 Km.)

Front brakes

Inspect brake pads: if worn unequally, change over their operating positions. This work should be carried out by an authorized Distributor/Dealer.

Sparking plugs

Remove the plugs and clean off all carbon deposit from the electrodes and plug threads with a stiff brush dipped in paraffin (kerosene).

Check the plug gaps, and reset if necessary to the recommended clearance (see 'GENERAL DATA'). When resetting bend the side electrode only—never bend the centre electrode as this may split the insulator tip.

When refitting the plugs, make sure that the copper washers are not defective in any way. If they have become worn and flattened, fit new ones to ensure a gas-tight joint. Screw the plug down by hand as far as possible, then use a spanner for tightening only. Always use a tubular box spanner to avoid possible damage to the insulator, and do not under any circumstances use a movable wrench. Never overtighten a plug, but ensure that a good joint is made between the plug body, washer, and cylinder head.

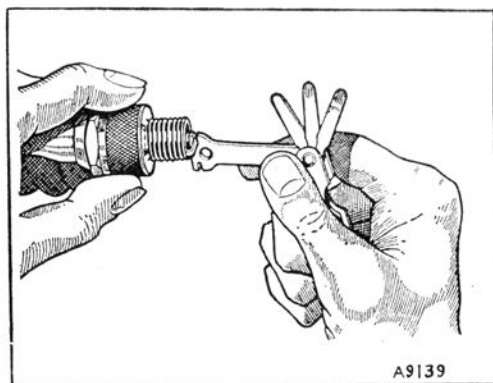

Use a Champion sparking plug gauge and setting tool. Move the side and never the centre electrode

The correct grade of sparking plug for use under normal driving conditions is the Champion N5. Plugs of a lower heat range (hotter running) should not be used, otherwise pre-ignition will occur, with consequent rise in combustion temperature and resulting engine damage. For competition work or hard driving where high output is consistently sustained the Champion N3 sparking plug should be used. This is a cooler-running plug and will ensure lower combustion temperatures and an increased margin of safety. Accumulated deposits of carbon, leaking or cracked insulators, and thin electrodes are all causes of pre-ignition. The plugs should therefore be examined, cleaned, and adjusted at the specified intervals and defective ones renewed.

Lamps

Check all lamps for correct functioning.

EVERY 6,000 MILES (10000 Km.)

Distributor (lubrication)

Cam bearing

Remove the rotor arm from the top of the distributor drive spindle and add a few drops of thin engine oil to the cam bearing. Do not remove the screw that is exposed to view; there is a clearance between the screw and the inner face of the cam spindle for the oil to pass. Replace the rotor arm with its drive lug correctly engaging the spindle slot and push it onto the spindle as far as it will go.

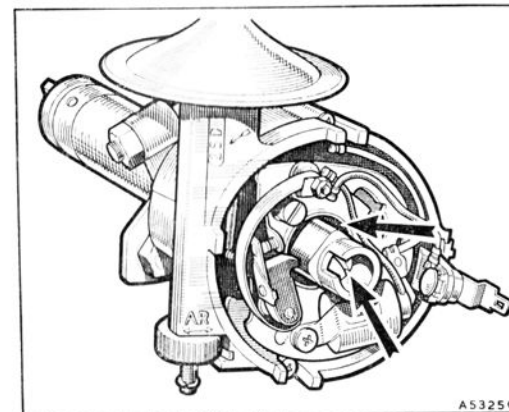

The distributor cam bearing and automatic timing control lubricating points

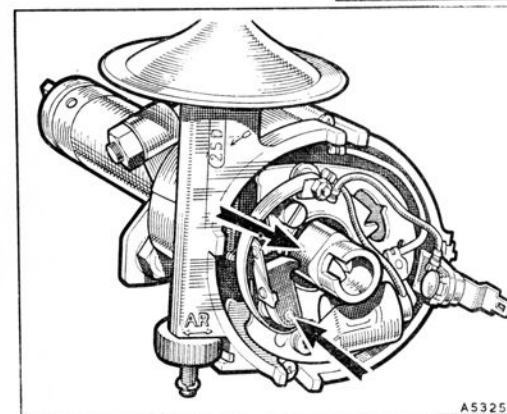

The distributor cam spindle and contact breaker lubricating points

Cam spindle and contact breaker pivot

Smear a very small amount of grease to Ref. C (page 68) on the cam spindle and also on the contact breaker pivot. Do not allow the grease to get on the contacts; lubricate sparingly.

Automatic advance control

Add a few drops of oil to Ref. A (page 68) through the hole in the contact breaker base plate to lubricate the automatic advance mechanism. Do not over-oil or allow any oil to get on or near the contacts. Carefully wipe away any surplus oil and see that the contact breaker points are clean.

EVERY 6,000 MILES (10000 Km.)

Distributor (mechanical check)

Check the functioning of the automatic advance and retard mechanism as follows.

Centrifugal advance mechanism

Remove the distributor cap and grasp the rotor firmly. Turn the rotor arm in the direction of rotation and release it. The rotor arm should return to its original position without showing any tendency to stick.

Vacuum advance

Use a screwdriver to check the movement of the moving plate. Where a modified cap having a window cut in the side is available fit the cap and start the engine. Open the throttle and observe the movement of the contact breaker plate.

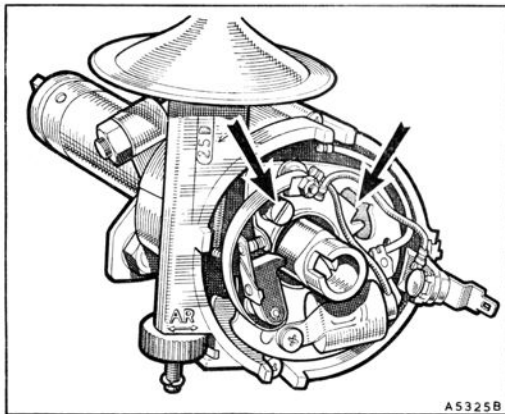

The distributor points, contact plate securing screws, and the (screwdriver) adjusting slot, indicated by arrows

Contact breaker

Remove the distributor cap and turn the crankshaft until the contacts are fully open. Check the gap with a feeler gauge (see 'GENERAL DATA'); the gauge should be a sliding fit in the gap. If the gap varies appreciably from the gauge thickness, slacken the contact plate securing screw (see illustration) and adjust the contact gap by inserting a screwdriver in the notched hole at the end of the plate and turning clockwise to decrease and anti-clockwise to increase the gap. Retighten the securing screw.

If the contact breaker points are burned or blackened, clean them with a fine carborundum stone or with fine emery-cloth.

Cleaning the contacts is made easier if the contact breaker lever carrying the moving contact is removed. To do this unscrew the nut securing the end of the spring, remove the spring washer, flat washer, and both lead terminals, and lift off the lever complete with spring. After cleaning refit the contact breaker and check the gap.

The high-tension cables connecting the distributor to the sparking plugs may, after long use, also show signs of perishing. They must then be replaced by the correct type of ignition cable. Cut the cables to length, fill the holes in the cap with silicone grease, push the cables well home in the cap, and secure with the pointed screws.

EVERY 6,000 MILES (10000 Km.)

Battery

Ascertain the state of charge of the battery by taking hydrometer readings (see page 22).

Front wheel alignment

Excessive and uneven tyre wear is usually caused by faulty wheel tracking. The wheels are set to toe in between 0 and $\frac{1}{8}$ in. (0 and 3.2 mm.) to each other. When checking the alignment of the front wheels, make certain that the measurements are taken at axle level, and that the wheel rims run true.

Correct setting of the front wheels entails the use of an alignment gauge.

Entrust this work to a Distributor/Dealer.

Front wheel alignment in the straight-ahead position. Dimension (A) must be between 0 and $\frac{1}{8}$ in. (0 and 3.2 mm.) greater than (B)

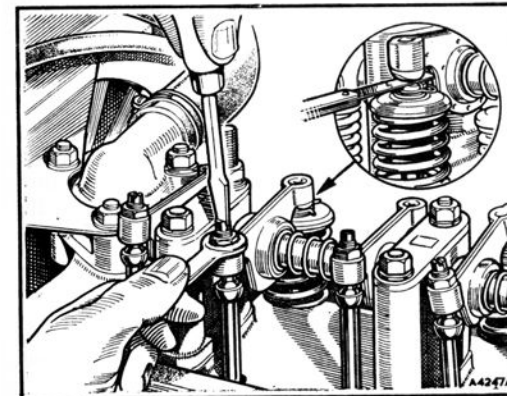
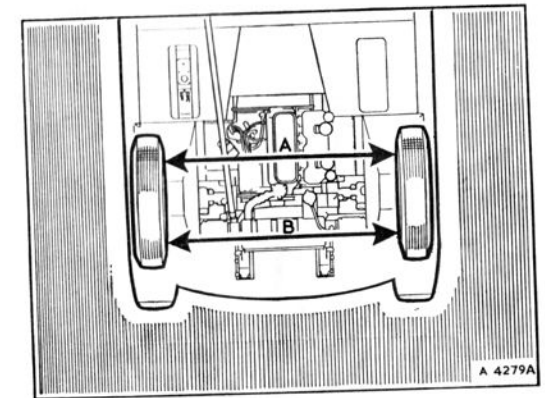

The method of setting the valve clearance, and (inset) using a feeler gauge to check the rocker clearance

Valve rockers

Test the clearance between the rocker arm and the valve stems by inserting a feeler gauge between them (see 'GENERAL DATA'). When cold the blade of the gauge should be a sliding fit. Adjustments must be made with the tappet on the back of the cam.

EVERY 6,000 MILES (10000 Km.)

Engine oil filter

The external oil filter is of the renewable element type and is located on the right-hand side of the engine crankcase. Remove the filter for cleaning, and fit a new element at the same time as the engine oil is changed. The filter is released by unscrewing the central securing bolt at the bottom of the container; oil will commence to drain from the container as soon as the bolt is unscrewed. Remove the old element and wash the container in fuel, dry it thoroughly, and make certain that the sealing washers are in good condition; renew them should there be any sign of deterioration. Care must be taken to ensure that the washers fitted below the element inside the container are fitted correctly. The small felt washer must be positioned between the element pressure plate and the metal washer above the pressure spring. It is essential for correct oil filtration that the felt washer is in good condition and a snug fit on the bolt.

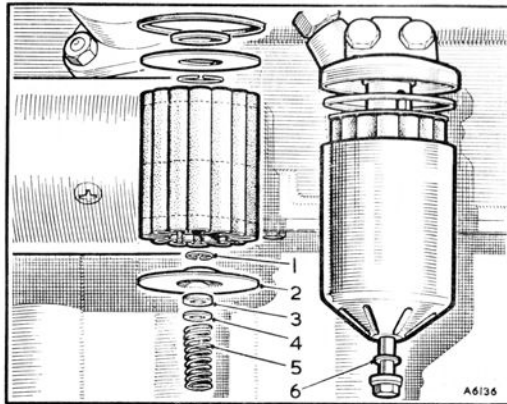

The engine oil filter, showing the positions in which the washers are fitted below the element

1. Retaining clip.
2. Element pressure plate.
3. Felt washer.
4. Steel washer.
5. Pressure spring.
6. Rubber washer (external).

Insert a new element into the container, hold the bolt head firmly against the bottom rubber sealing washer, and fill the container with new oil. Refit the assembly to the filter head, keeping the bolt head pressed against the bottom sealing washer to prevent the oil draining.

Check the filter for signs of leakage immediately the engine is started.

Make quite certain that the correct element is obtained for the type of filter fitted.

Dynamo bearing

Add two or three drops of engine oil to Ref. A (page 68) to the dynamo bearing through the central hole in the rear end bearing plate. Do not over-oil.

For the complete summary of attention to be given every 6,000 miles (10000 km.) refer to pages 52 and 53.

EVERY 12,000 MILES (20000 Km.)

Steering

A lubrication point is provided at the left-hand side of the rack housing (right-hand side on left-hand-drive vehicles), accessible when the bonnet is raised. Replenish the oil in the housing via this nipple with oil to Ref. B (page 68). Avoid overfilling; do not give more than 10 strokes of the oil gun.

Sparking plugs

Fit a new set of sparking plugs of the type and make recommended and given under 'GENERAL DATA' on page 4. Check the plug gap before installing the new plugs.

General

Check rear road spring seat bolts.

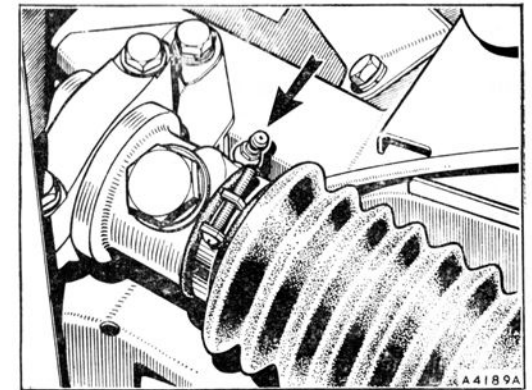

The steering-rack lubrication nipple

Water pump

Remove the plug on the water pump casing and inject a small quantity of grease to Ref. C (page 68). Lubrication of the water pump must be done very sparingly, otherwise grease will seep past the bearings onto the face of the carbon sealing ring and impair its efficiency.

Air cleaners

Fit new air cleaner elements every 12,000 miles (20000 km.), or earlier in dusty operating conditions. Remove the interconnecting bracket securing nut and the air cleaner through-bolts. Lift the assemblies from the induction pipe, prise off the covers, and extract the elements. Clean the containers thoroughly before fitting the new elements. Do not remove the covers or disturb the elements at any other time.

For a complete summary of maintenance to be carried out every 12,000 miles (20000 km.) refer to pages 53 and 54.

BODYWORK

Coachwork

Regular care of the body finish is necessary if the new appearance of the car exterior is to be maintained against the effects of air pollution, rain, and mud.

Wash the bodywork frequently, using a soft sponge and plenty of water containing a mild detergent. Large deposits of mud must be softened with water before using the sponge. Smears should be removed by a second wash in clean water, and with the sponge if necessary. When dry, clean the surface of the car with a damp chamois-leather. In addition to the regular maintenance, special attention is required if the car is driven in extreme conditions such as sea spray, or on salted roads. In these conditions and with other forms of severe contamination an additional washing operation is necessary, which should include underbody hosing. Any damaged areas should be immediately covered with paint and a complete repair effected as soon as possible. Before touching-in light scratches and abrasions with paint thoroughly clean the surface. Use petrol/white spirit (gasoline/hydrocarbon solvent) to remove spots of tar or grease.

The application of B.M.C. Car Polish is all that is required to remove traffic film and to ensure the retention of the new appearance.

Bright trim

Never use an abrasive on stainless, chromium, aluminium, or plastic bright parts and on no account clean them with metal polish. Remove spots of grease or tar with petrol/white spirit (gasoline/hydrocarbon solvent) and wash frequently with water containing a mild detergent. When the dirt has been removed polish with a clean dry cloth or chamois-leather until bright. Any slight tarnish found on stainless or plated parts which have not received regular washing may be removed with B.M.C. Chrome Cleaner. An occasional application of mineral light oil or grease will help to preserve the finish, particularly during winter when salt may be used on the roads, but these protectives must not be applied to plastic finishes.

Windshield

If windshield smearing has occurred it can be removed with B.M.C. Screen Cleaner.

Interior

Clean the carpets with a stiff brush or vacuum cleaner, preferably before washing the outside. The upholstery, carpets, and roof lining may be treated with B.M.C. 2-way Cleaner applied with a damp cloth and a light rubbing action. The best result will be obtained on carpets if the solution is applied with a soft brush.

A razor blade will remove transfers from the window glass.

Cleaning the hood

To clean the hood it is only necessary to use soap and water, with a soft brush to remove any ingrained dirt. Frequent washing with soap and water considerably improves the appearance and wearing qualities of the hood, and it should be washed at least as often as the rest of the car.

Do not use caustic soaps, detergents, or spirit cleaners to clean the hood or the hood back-light.

The B.M.C. approved products mentioned above are obtainable from your Distributor or Dealer.

MAINTENANCE SUMMARY

MAINTENANCE SUMMARY

Daily

- Inspect engine oil level, and top up as necessary.
- Check water level in radiator, and top up if necessary.

Weekly

- Check battery and top up to correct levels.
- Test tyre pressures.

3,000 miles (5000 km.) or 3 months service

- Engine*
 - Check water level in radiator, and top up if necessary.
 - Top up carburettor piston dampers.
- Brakes*
 - Check brakes, and adjust if necessary.
 - Make visual inspection of brake lines and pipes.
 - Check level of fluid in the hydraulic supply tank, and top up if necessary.
- Electrical*
 - Check battery and top up to correct levels.
- Lubrication*
 - Lubricate all grease nipples (except steering rack and pinion).
 - Change engine oil (if using monograde only).
- Wheels and tyres*
 - Check tyre pressures.

6,000 miles (10000 km.) or 6 months service

- Engine*
 - Check water level in radiator, and top up if necessary.
 - Top up carburettor piston dampers.
 - Check fan belt tension.
 - Check valve rocker clearances, and adjust if necessary.
- Ignition*
 - Check functioning of automatic advance and retard mechanism.
 - Check, and adjust if necessary, distributor contact points.
 - Lubricate all parts as necessary.
 - Clean and adjust sparking plugs.
- Brakes*
 - Check brakes, and adjust if necessary.
 - Make visual inspection of brake lines and pipes.
 - Check level of fluid in the hydraulic supply tank, and top up if necessary.
 - Inspect disc brake friction pads and report if attention is required.

MAINTENANCE SUMMARY

- Steering*
 - Check wheel alignment, and adjust if necessary.
- Electrical*
 - Check battery cell specific gravity readings and top up to correct levels.
 - Lubricate the dynamo bearing.
 - Check all lamps for correct functioning.
- Lubrication*
 - Change oil in engine.
 - Fit new oil filter element.
 - Top up oil levels in gearbox and rear axle.
 - Lubricate all grease nipples (except steering rack and pinion).
- Wheels and tyres*
 - Check tyre pressures.

9,000 miles (15000 km.) or 9 months service

Carry out the 3,000 miles (5000 km.) or 3 months service.

12,000 miles (20000 km.) or 12 months service

- Engine*
 - Top up carburettor piston dampers.
 - Check water level in radiator, and top up if necessary.
 - Check fan belt tension.
 - Lubricate water pump sparingly.
 - Check valve rocker clearances, and adjust if necessary.
 - Fit new air cleaner elements.
- Ignition*
 - Check functioning of automatic advance and retard mechanism.
 - Check, and adjust if necessary, distributor contact points.
 - Lubricate all parts as necessary.
 - Fit new sparking plugs.
- Steering*
 - Check steering and suspension moving parts for wear.
 - Check wheel alignment, and adjust if necessary.
- Brakes*
 - Check brakes, and adjust if necessary.
 - Make visual inspection of brake lines and pipes.
 - Check level of fluid in the hydraulic supply tank, and top up if necessary.
 - Inspect disc brake friction pads and report if attention is required.
- General*
 - Check rear road spring seat bolts.

MAINTENANCE SUMMARY

6. *Electrical*

- Check battery cell specific gravity readings and top up to correct levels.
- Lubricate dynamo bearing.
- Check all lamps for correct functioning.

7. *Lubrication*

- Top up oil level in gearbox and rear axle.
- Fit new oil filter element.
- Change oil in engine.
- Lubricate all grease nipples.
- Lubricate steering rack and pinion.

8. *Wheels and tyres*

- Check tyre pressures.

SUPPLEMENTARY TOOL KIT

To supplement the tool kit a roll containing the following is obtainable from all Distributors. Part No. 97H 524 should be quoted.

- 4 spanners: $\frac{5}{16}$ in. \times $\frac{3}{8}$ in. A.F.
- $\frac{7}{16}$ in. \times $\frac{1}{2}$ in. A.F.
- $\frac{9}{16}$ in. \times $\frac{5}{8}$ in. A.F.
- $\frac{11}{16}$ in. \times $\frac{3}{4}$ in. A.F.
- 1 pair 6 in. pliers.
- 1 adjustable spanner (7 in.).
- 1 tommy-bar ($\frac{3}{8}$ in. diameter).
- 1 tubular spanner ($\frac{1}{2}$ in. \times $\frac{9}{16}$ in. A.F.).
- 1 Phillips screwdriver.

B.M.C. SEAT BELTS

Seat belts are available from B.M.C. Service Ltd. Fitting should only be carried out by an authorized Distributor/Dealer.

The complete seat belt is made up of two sections, both adjustable, which, when in use, are connected by a quick-action buckle. The end bracket (with the two holes) of the long belt is bolted to the wheel arch and the other end is attached to the sill with the bolt supplied. The bracket on the end of the short belt is bolted to the wearer's side of the propeller shaft tunnel. When in use

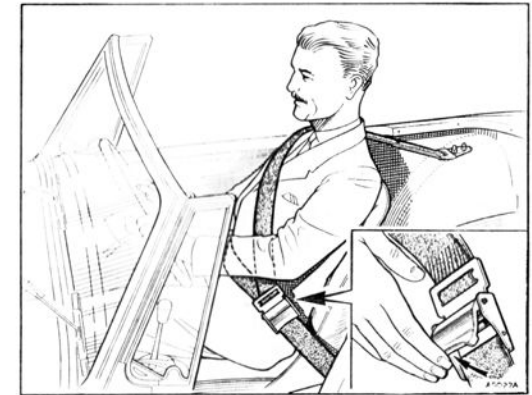

When fitting ensure that the seat belt buckle is in the position shown

the long belt passes from the wheel arch downwards across the chest to the sill with the buckle tongue approximately at its centre. The short belt from the tunnel is adjusted so that the buckle is located just in front of the hip, and the tongue on the long belt is pushed into the buckle until it clicks in the locked position. The long belt is then adjusted so that the wearer is held firmly but comfortably in the seat. For quick release it is only necessary to lift up the buckle lever, which immediately frees the wearer.

Take care to stow the long belt in such a way that you are not tripped when getting out of the car.

IMPORTANT

Your attention is drawn to the following points, compliance with which, we suggest, will prove mutually beneficial.

1. WARRANTY DOCUMENT

Retention of the Certificate or Passport to Service, signed by the Distributor or Vendor, in a safe place **in the vehicle** will (by quickly establishing the date of sale) help to expedite any adjustments under Warranty if such adjustments are required to be carried out by a B.M.C. Distributor or Dealer other than the supplier of your vehicle.

2. CLAIMS UNDER WARRANTY

Claims for the replacement of material or parts under Warranty must be submitted to the supplying Distributor or Dealer, or, when this is not possible, to the nearest Distributor or Dealer, informing them of the Vendor's name and address.

Except in cases of emergency, Warranty work should always be carried out by a franchise holder, since this ensures that no doubt can arise in connection with circumstances of the vehicle history when claims are put forward.

3. PREVENTIVE MAINTENANCE

A Passport to Service containing Service Vouchers (applicable in the United Kingdom only) is provided with every new vehicle, and the regular use of the Vouchers in sequence is the best safeguard against the possibility of abnormal repair bills at a later date. Replacement Passport to Service Books are obtainable free of charge from Distributors and Dealers. **Prevent rather than Cure.**

Regular servicing, proved by completed Voucher counterfoils, could well enhance the value of your vehicle in the eyes of a prospective buyer.

4. REPLACEMENT PARTS

When Service Parts are required insist on B.M.C. GENUINE PARTS as these are designed and tested for your vehicle and in addition warranted for 12 months by the British Motor Corporation. ONLY WHEN GENUINE PARTS ARE USED CAN B.M.C. ACCEPT RESPONSIBILITY.



When purchasing replacement parts or having repairs done owners are requested to see that a label similar to the one illustrated here is attached to the invoice rendered. These labels are issued by Service B.M.C. Limited and constitute a guarantee that B.M.C. GENUINE PARTS are supplied.

Our world-wide network of Distributors and Dealers is at your service.

B.M.C. SERVICE LIMITED

Proprietors: The British Motor Corporation Limited

COWLEY · OXFORD · ENGLAND

Telephone: Oxford 77777 Telegrams: BMC SERV. Telex. Oxford

Telex: BMC SERV. Oxford 83145 and 83146

Overseas Cables: BMC SERV. Telex. Oxford. England

M.G. MIDGET

(Mark I)

SUPPLEMENT

GENERAL DATA

Early models

Engine

Engine type	9GC (4-cylinder overhead-valve)
Bore	2.478 in. (62.94 mm.)
Stroke	3.00 in. (76.2 mm.)
Cubic capacity	59.87 cu. in. (948 cc.)
Compression ratio	9:1 or 8.3:1

Ignition

Static ignition timing	(H.C.) 4° B.T.D.C. (L.C.) 1° B.T.D.C.
------------------------	-------	--

Fuel System

Carburettor needles	Standard V3, Weak GX, Rich V2
Spring	Light blue
Pump	AC 'Y' type (mechanical)

Transmission

Overall gear ratio:		
Reverse	7.361:1

Weight

Dry weight	1400 lb. (635 kg.)
------------	-------	--------------------

Dimensions

Track: Front	3 ft. 9 $\frac{3}{4}$ in. (1.16 m.)
Rear	3 ft. 8 $\frac{3}{4}$ in. (1.14 m.)

Later models

Fuel System

Carburettor needles	Standard GY, Weak GG, Rich M
Spring	Blue

Wheels and Tyres

Tyre pressures:		
All conditions: <i>Gold Seal</i> <i>Gold Seal C41</i>		
Front	18 lb./sq. in. (1.27 kg./cm. ²) 18 lb./sq. in. (1.27 kg./cm. ²)
Rear	20 lb./sq. in. (1.41 kg./cm. ²) 24 lb./sq. in. (1.69 kg./cm. ²)
For sustained speeds in excess of 80–85 m.p.h. (129–137 km.p.h.):		
Front	24 lb./sq. in. (1.69 kg./cm. ²) 22 lb./sq. in. (1.55 kg./cm. ²)
Rear	26 lb./sq. in. (1.83 kg./cm. ²) 28 lb./sq. in. (1.97 kg./cm. ²)

Weight

Dry weight	1,466 lb. (665 kg.)
------------	-------	---------------------

CONTROLS AND INSTRUMENTS

Starter switch

The starter motor is controlled by a switch located on the fascia panel. Pull the knob marked 'S' to operate the starter, and release it as soon as the engine fires. Should the engine fail to start the first time, wait until the crankshaft stops turning before pulling the knob again. Do not run the battery down by keeping the starter turning when the engine will not start.

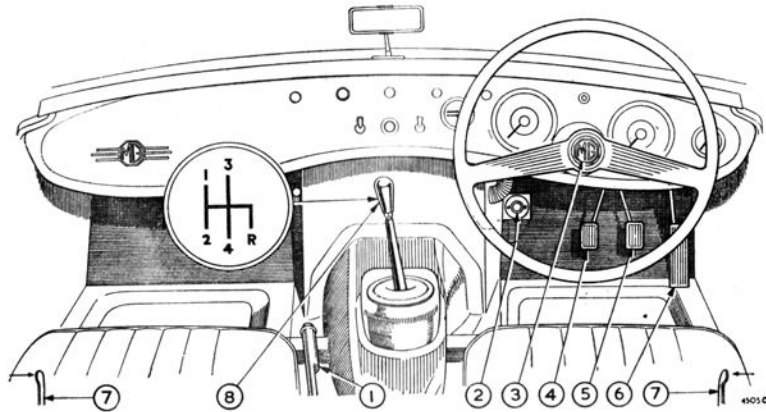

Driving controls—right-hand drive

- | | |
|---------------------------|-------------------------|
| 1. Hand brake | 5. Brake pedal. |
| 2. Headlights dip switch. | 6. Accelerator pedal. |
| 3. Horn switch. | 7. Seat adjuster locks. |
| 4. Clutch pedal. | 8. Gear lever. |

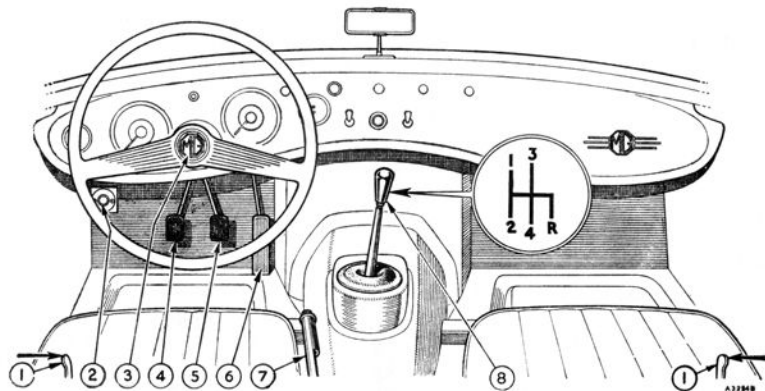

Driving controls—left-hand drive

- | | |
|--------------------------|-----------------------|
| 1. Seat adjuster locks. | 5. Brake pedal. |
| 2. Headlight dip switch. | 6. Accelerator pedal. |
| 3. Horn switch. | 7. Hand brake. |
| 4. Clutch pedal. | 8. Gear lever. |

CONTROLS AND INSTRUMENTS

Ignition switch

The ignition switch is located in the centre of the fascia panel and is operated with a removable key. Do not leave the ignition switched on when the engine is not running.

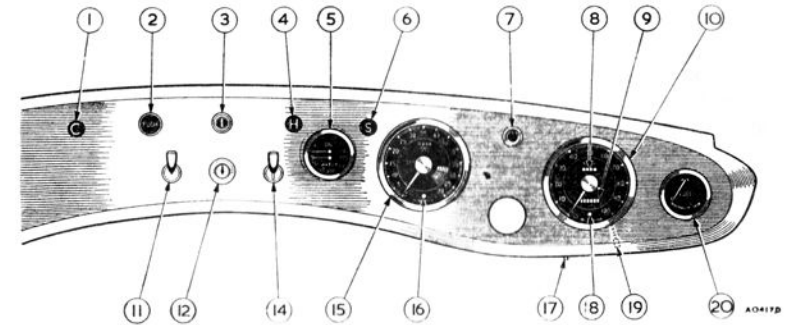

Driving controls—right-hand drive

- | | |
|--|--|
| 1. Choke. | 10. Speedometer. |
| 2. Windshield washer. | 11. Windshield wiper switch. |
| 3. Direction indicator switch. | 12. Ignition switch. |
| 4. Heater switch. | 14. Lighting switch. |
| 5. Oil pressure and water temperature gauge. | 15. Tachometer. |
| 6. Starter. | 16. Ignition warning light. |
| 7. Direction indicator warning light. | 17. Panel light switch. |
| 8. Trip mileage indicator. | 18. Headlight main-beam warning light. |
| 9. Total mileage indicator. | 19. Trip mileage resetting knob. |
| | 20. Fuel gauge. |

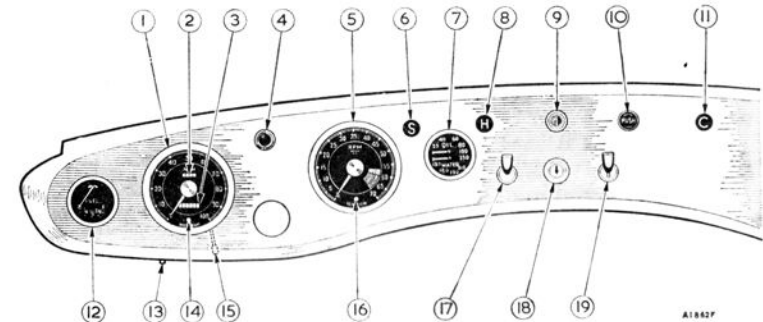

Instruments and switches—left-hand drive

- | | |
|--|--|
| 1. Speedometer. | 10. Windshield washer. |
| 2. Trip mileage indicator. | 11. Choke. |
| 3. Total mileage indicator. | 12. Fuel gauge. |
| 4. Direction indicator warning light. | 13. Panel light switch. |
| 5. Tachometer. | 14. Headlight main-beam warning light. |
| 6. Starter. | 15. Trip mileage resetting knob. |
| 7. Oil pressure and water temperature gauge. | 16. Ignition warning light. |
| 8. Heater switch. | 17. Windshield wiper switch. |
| 9. Direction indicator switch. | 18. Ignition switch. |
| | 19. Lighting switch. |

CONTROLS AND INSTRUMENTS

Direction indicators

The flashing direction indicator switch is located on the centre of the fascia panel. Move the switch to the right or left according to the indicator required. A warning light on the fascia panel flashes as long as the indicators are in use. The indicators operate only when the ignition is switched on.

Choke

Pull the knob out to its limit when starting from cold, and push it in completely as soon as the engine will run without a rich mixture. Never allow the engine to run for long periods with knob pulled out.

BODY DETAILS

Hood

Erecting the hood

Remove the hood from its stowed position (see page 63). Place the main hood stick in the body sockets with the hinged rail facing forward, then with the peg in line with the slot press the main hood stick downwards to compress the tension springs, and lock both sides in this position.

Place the hood over the open framework, fit the front rail of the hood into the lip of the windshield frame, and secure it with the fastener at each top corner of the windshield.

Attach the rear hood rail to the two slotted fasteners on the tonneau panel and the hood sides to the body with the turn-buttons and fasteners.

Secure the front rail firmly into the lip of the windshield frame

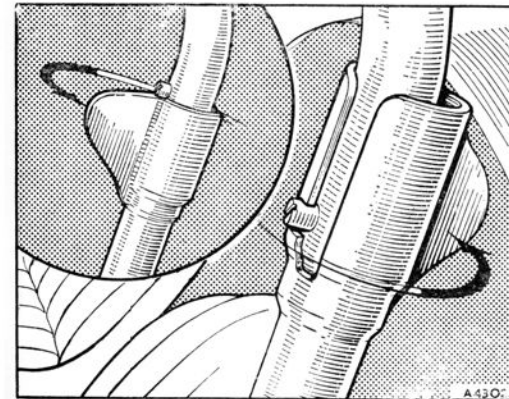
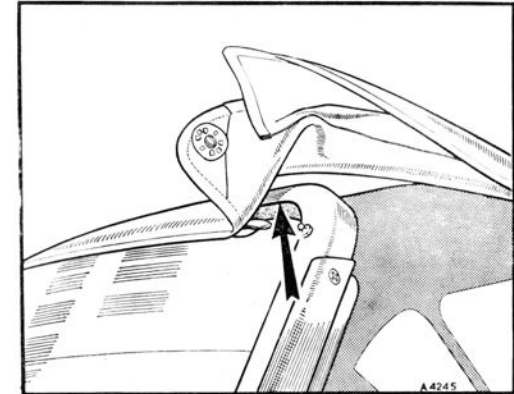

Turn the lug until the locking peg is in line with the slot. Push the hood stick downwards and rotate the lug as indicated to lock the telescopic end of the hood stick in the compressed position

Make certain that the front hood rail is still firmly secured in the lip of the windshield and release the telescopic hood stick from compression. Turn the lug to the position shown in the illustration.

Removing the hood

Turn the lug until the locking peg is in line with the slot. Apply downward pressure on both sides of the main hood stick to compress the tension springs

BODY DETAILS

and lock it in this position by rotating the lug on the bottom section of the frame to engage the locking peg with the retainer. Release the fasteners and turn-buttons on the body side: pull the fasteners to release them from their retainers. Slide the rear hood rail backwards clear of the two slotted fasteners on the tonneau panel, release the front rail from the retaining lip on the windshield, and lift the hood from the frame.

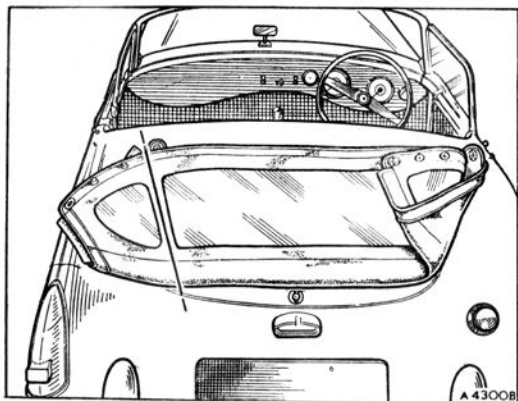

Fold the quarter-lights inwards, folding on a line between the quarter-light and back-light

Finally, roll the hood as shown for storage

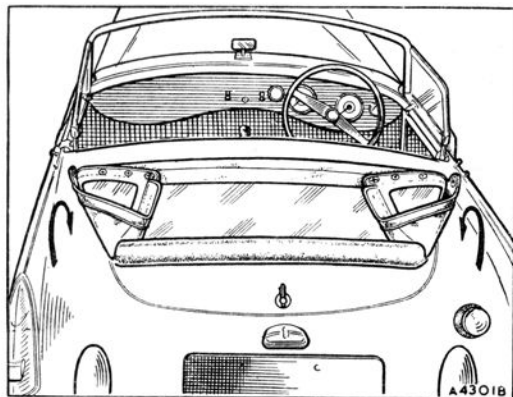

NOTE.—It is most important that the instructions given should be followed when folding and stowing the hood in order to obviate damage to the quarter- and back-lights. Never fold the hood when it is wet or damp. Wait until it is perfectly dry.

Folding the hood

Folding the hood correctly is of utmost importance; lay the hood on a flat surface with the lining upwards. Fold the hood in the way shown in the illustration and then roll it up carefully, avoiding kinking.

BODY DETAILS

Stowing the hood and hood sticks

The hood should be rolled up carefully to avoid damaging the back-lights, placed in the bag provided, there is also a bag provided for the hood sticks, and both should be stowed away in the luggage compartment beneath the tonneau panel.

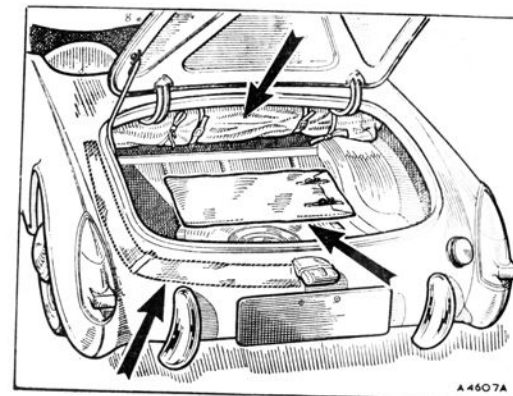

The hood, hood sticks, and sidescreens stowed away in the luggage compartment

PERIODICAL MAINTENANCE

BODY DETAILS

Hard top

Fitting the hard top

Remove the hood and stow it away, following the instructions given.

Place the hard top in position on the car and insert the securing bolts through the two side brackets into the existing hood stick sockets.

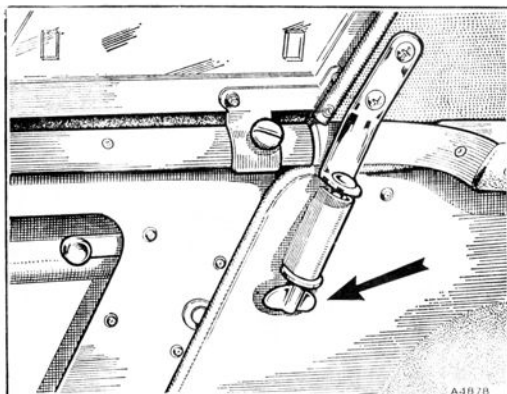

One of the two hard top fixing brackets with the bolt inserted through the body bracket, securing it to the hood stick socket with a wing nut

The two roof panel to windshield frame clamps. Make certain that the hook of the clamp is correctly positioned under the lip of the windshield frame before the clamp is secured in position

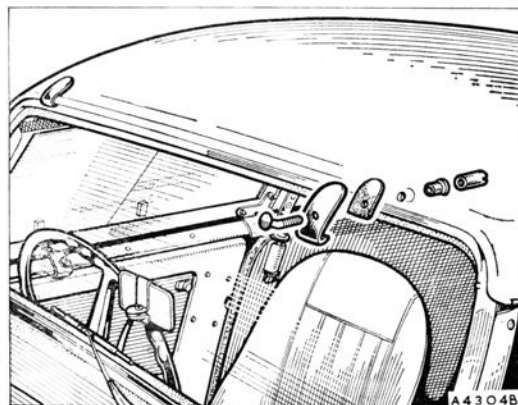

Locate the roof clamps in the holes in the top of the hard top and hold them securely in position under the lip of the windshield frame. From inside the car fit the stepped sleeve onto the roof clamp. Fit the tube locking screw and together with the wing nuts on the rear section pull the hard top into position.

EVERY 3,000 MILES (5000 Km.)

Brakes

Check the operation of the brakes and, if necessary, adjust as follows:

Front brakes: Apply the handbrake, jack up one front wheel until it is free to revolve. Spin the wheel in a forward direction and apply the foot-brake firmly to centralize the shoes in the drum. Remove the wheel cap, extract the rubber dust sealing plug from the adjuster hole in the wheel and align the hole with the screwdriver slot on one wheel cylinder. Insert a screwdriver and turn in a clockwise direction until the brake shoe bears hard against the drum. Back off the adjustment the least possible amount (usually two or three clicks) until the wheel is free to revolve. Repeat these operations at the other wheel cylinder. Replace the wheel cap. Adjust the opposite front brakes in a similar manner.

Rear brakes: Place chocks under the front wheels, release the handbrake and jack up one rear wheel until it is free to revolve. Remove the wheel cap and proceed as for the front brakes, but, as there is only one adjusting point for both shoes, the adjuster must be turned until one shoe bears against the drum, then continue turning until both shoes bear hard. Back off the adjustment the least possible amount until the wheel can be revolved freely (the amount of backing off may be slightly more than was needed for the front brakes). Replace the wheel cap. Adjust the opposite rear wheel brakes in a similar manner.

EVERY 6,000 MILES (10000 Km.)

Dynamo

Unscrew the cap of the lubricator on the side of the bearing housing, lift out the felt pad and spring, and half fill the cap with grease to Ref. C (page 68). Replace the spring and pad, and screw the cap back into position.

INDEX

	<i>Page</i>
A	
Air cleaners	49
B	
Battery	22
Body details	12-15
Bodywork	50
Bonnet lock	12
Brakes	41
Adjustment	41
Fluid	6
Hand Brake	40
Hand Brake cable	40
Bulbs, replacement	27
C	
Cables, high-tension	46
Carburettors	35
Adjustment	35
Car number	3
Cooling system	18
Anti-freeze	18
Draining	18
Filling	18
D	
Data, general	4
E	
Electrical equipment	22
Engine	3
Number	19
Running in	19
Starting	19
F	
Fan belt	43
Filter	48
External oil	3
Foreword	19
Fuel	23
Filling up	19
Fuses	23
G	
Gauges	8
Fuel	9
Oil	9
Temperature	9
Gear lever	6
H	
Heater and ventilating control	7
Heating and ventilating	11
High-compression engine tuning	20
Hood	14

	<i>Page</i>
I	
Ignition	23
Coil	21
Setting	21
Instruments	9
Speedometer	9
Tachometer	10
J	
Jack and jacking	31
L	
Lights	26, 27
Flashing indicator	24
Headlamps	27
Number-plate lamp	27
Panel and warning	26
Sidelamps	27
Stop/tail lamps	27
Lubrication	39
Carburetter	Centre of Book
Diagram	45
Distributor	48
Dynamo	43
Engine	42
Gearbox	40
Hand brake cable	40
Propeller shaft	42
Rear axle	68
Recommended lubricants	49
Steering	39
Swivel pins	49
Water pump	49
M	
Maintenance summary	51-54
N	
Number, identification	3
P	
Pedal controls	6
Periodical maintenance	37-49
R	
Running instructions	19
S	
Seat adjustment	12
Seat belts	55
Sparking plugs	44
Starter	24
Supplement (Mk. 1 cars)	57-65
Switches	8
Headlamps	7
Headlight dipping	6
Horn	7
Ignition, starter	8
Panel lights	8
Sidelamps	8
Windshield wiper	10

INDEX

	<i>Page</i>
T	
Tonneau cover	16
Tool kit, supplementary	54
V	
Valve rocker clearance	47
Voltage regulator	23
W	
Warranty	56
Wheel alignment	47
Wheels and tyres	32, 34
Windshield washer	10
Windshield wiper	24
Wiring diagram	28, 29

KEY TO RECOMMENDED LUBRICANTS

	A	B	C	D
Component	Engine, Gear Box, Oilcan, and Carburetter	Rear Axle and Steering Gear	All Grease Points	Upper Cylinder Lubrication
Climatic conditions	All temperatures above -18° C. (0° F.)	All conditions down to -12° C. (10° F.)	All conditions	All conditions
BP	BP Visco-static	Energol E.P. S.A.E. 90	Energol L. 2	Energol U.C.L.
SHELL	Shell X-100 Multigrade 10W/30	Shell Spirax 90 E.P.	Shell Retinax A	Shell Upper Cylinder Lubricant
FILTRATE	Filtrate 10W/30 Multigrade	Filtrate Hypoid Gear 90	Filtrate Super Lithium Grease	Filtrate Petroyle
STERNOL	Sternol Multiplie	Ambroleum E.P. 90	Ambroline L.H.T.	Sternol Magikoyl
DUCKHAM'S	Q. 5500	Duckham's Hypoid 90	Duckham's L.B. 10 Grease	Duckham's Adcoid Liquid
CASTROL	Castrolite*	Castrol Hypoy	Castrol L.M.	Castrollo
ESSO	Esso Extra Motor Oil 20W/30*	Esso Gear Oil G.P. 90	Esso Multipurpose Grease H	Esso Upper Cylinder Lubricant
MOBIL	Mobiloil Special	Mobilube G.X. 90	Mobilgrease M.P.	Mobil Upperlube

Approval is also given to Duckham's Q. 20/50 oil, BP Visco-static Longlife oil and to monograde or single-viscosity lubricants supplied by companies listed in this chart.

* For temperatures below -12° C. (10° F.) use an S.A.E. 10W/30 grade oil. This is available in markets where such low temperatures prevail.

AKD 3898 A